

Contents

GENERAL WARNING	p. 3
A special note for parents	p. 3
1. First	
A. Bike Fit	p. 4
B. Safety First	p. 4
C. Mechanical Safety Check	p. 5
D. First Ride	p. 7
2. Safety	
A. The Basics	p. 8
B. Riding Safety	p. 9
C. Off Road Safety	p. 10
D. Wet Weather Riding	p. 10
E. Night Riding	p. 11
F. Extreme, Stunt Or Competition Riding	p. 12
G. Changing Components Or Adding Accessories	p. 13
3. Fit	
A. Standover Height	p. 14
B. Saddle Position	p. 15
C. Handlebar Height And Angle	p. 17
D. Control Position Adjustments	p. 18
E. Brake Reach	p. 18
4. Technical	
A. Wheels	p. 19
1. Wheel Quick Release	p. 19
2. Removing And Installing Quick Release Wheels	p. 20
3. Removing And Installing Bolt-On Wheels	p. 23
B. Seatpost Quick Release	p. 24
C. Brakes	p. 25
D. Shifting Gears	p. 27
E. Pedals	p. 29
F. Bicycle Suspension	p. 30
G. Tyres and Tubes	p. 31
H. BMX Stunt Pegs	p. 32
5. Servicing	
A. Service Intervals	p. 33
B. If Your Bicycle Sustains An Impact	p. 34
6. Children's Bikes	
A. Special Instructions	p. 41
Appendix A:	
Life Expectancy Of Your Bike And Its Components	p. 35

NOTE:

This manual is not intended as a comprehensive use, service, repair or maintenance manual. Please see your Halfords Bikehut store for all service, repairs or maintenance.

IMPORTANT:

This manual contains important safety, performance and service information. Read it before you take the first ride on your new bicycle, and keep it for reference. Additional safety, performance and service information for specific components such as suspension or pedals on your bicycle, or for accessories such as helmets or lights that you purchase, may also be available. Make sure that your Halfords Bikehut store has given you all the manufacturers' literature that was included with your bicycle or accessories. If you have any questions or do not understand something, take responsibility for your own safety and consult with your Halfords Bikehut store.

Halfords Lifetime Guarantee

Our Limited Lifetime Cycle Guarantee includes free replacement of the frame and rigid forks of all Halfords and Halfords exclusive brands for the original owner. For any of our own brand bikes, providing the damage was down to a manufacturing defect, you can enjoy a lifetime of cover and a peace of mind. On top of this, we also cover all other components on the bike for 1 year unless the manufacturer states otherwise.

Paintwork – this has a 2 year guarantee

Suspension forks – these have a Guarantee from the manufacturer that's normally 2 years.

Other components – most components will usually carry their own Guarantee, ranging from 1 year upwards depending on the brand.

Failure of components caused by misuse, lack of servicing and/or care – looking after your bike is important. This includes keeping it clean, well serviced and using it for what it's intended for. If you push a bike past what it was designed to do then you're more likely to cause harm to the bike and disqualify your Guarantee rights.

Electric components – the Guarantee on these usually vary between 1 year and 2 years depending on the brand.

What's classed as a "manufacturing defect"?

A manufacturing defect is where a component fails or shows a sign of failure due to poor manufacturing from the factory.

If your bike is having issues and it's not technically classed as a manufacturing defect, look at the "What happens if I crash my bike" section.

What's not covered for a lifetime?

It's important to understand that all bike parts are subject to general wear and tear, frames and forks included. This is where a bike part has simply done what was expected of it and has worn out or failed through general use.

Some of the more common parts subject to general wear and tear are usually the bike chain, cassette, brake pads and tyres. In this case, your Lifetime Cycle Guarantee won't cover the replacement cost.

Your guarantee will also be void if you modified or alter your bike in a way that affects its geometry or puts unnecessary stress on the structure of it.

Need to make a guarantee claim?

If you find yourself needing to make a guarantee claim, then please take your bike into any Halfords store with proof of purchase. If the bike was purchased online or you're unable to make the journey to store, get in touch with our customer support team.

Please don't try and repair any damage that may have occurred, as this can affect our guarantee assessment. Just leave it to our shop colleagues and they will assess your bike, find out what caused the failure and find a solution.

As part of our Limited Lifetime Cycle Guarantee, we'll replace the frame/fork with a model that is either like for like, or an upgrade to the previous model for the first 2 years of ownership.

After 2 years, we'll provide a replacement of the next best frame on offer at that time.

Please note, due to the models of your bike changing over time, component compatibility, design and geometry may vary. If we can't replace the frame or fork, we'll offer you a replacement bike of a similar retail price value.

There are no refunds or vouchers given in exchange.

What happens if I crash my bike?

Sometimes accidents happen and won't be classed as a manufacturing defect. However, as we want to help you get back on your bike as quickly as possible, we'll happily offer a replacement frame and/or forks, plus our fitting service at a reduced price.

Please note, we'll offer the closest available product at the time of your claim, please contact your local store or our Customer Support team for more detail.

Providing that the cycle:

- Has been properly cared for, regularly serviced and maintained.
- Has only been fitted with parts recommended by Halfords.
- Has not been modified or altered in any way.
- Has not been damaged by accident or misuse.

Any failure caused by normal wear and tear or a lack of servicing and maintenance is excluded.

Under the terms of this guarantee Halfords will bear the cost of the replacement parts and labour to carry out the repair.

Important: This guarantee applies only to cycles used under normal riding conditions. The components specified on all terrain cycles are guaranteed for normal off road use. However, no cycles sold by Halfords are guaranteed to withstand stunt riding, jumping, trials riding, misuse, accidents, lack of maintenance, abuse, use in competition or commercial use (e.g. hire). This guarantee does not affect your statutory rights. Suitable terrain City and Trekking bikes are designed only for use on roads, cycle paths and smooth trail paths. Young adult bikes are designed only for riders who weigh less than 40kg (6st 4lbs) to use on roads, cycle paths & smooth trail paths Mountain and Jump style bikes are designed for on road and moderate off road use only. They are not intended for extreme off road conditions, severe downhill riding or for jumping and stunt riding. Racing bikes are designed for use on roads and other smooth tarmac surfaces only. BMX bikes are designed for use on roads, smooth tracks and ramps. If the rider has sufficient skills, they can be used for acrobatic ground manoeuvres and stunt riding.

Hazard of misuse The misuse of any bike will subject both the frame and components to excessive loading; this will greatly accelerate wear and ultimately cause failure. Any such failure of the frame or components could result in serious injury. (see section 2F and Appendix A).



Maximum weights

Unless otherwise stated, adult bicycles are designed to carry a rider of up to 120 Kg (18st 12lbs) and up to 20 Kg of luggage. All luggage carried must be securely mounted on the frame, uniformly distributed and fitted as low as possible, to minimize any adverse effect upon stability. The maximum total weight of the cycle, rider and luggage should never exceed 160 Kg. Unless otherwise stated, folding bikes are designed to carry a rider of up to 85kg (13st 5lbs) and up to 15Kg of luggage. Unless otherwise stated, children's bicycles are BMX category 1 (Cat 1) bicycles are designed to carry a rider of up to 45 Kg (7st) and no luggage. BMX category 2 (Cat 2) bicycles are designed to carry a rider of up to 80 Kg (12st 8lbs). The maximum total weight of the cycle, rider and luggage should never exceed 90 Kg. designed to carry a rider of up to 45 Kg (7st) and no luggage. The maximum total weight of the cycle and rider should never exceed 60 Kg.

GENERAL WARNING:

Like any sport, cycling involves risk of injury and damage. By choosing to ride a bicycle, you assume the responsibility for that risk, so you need to know – and to practice – the rules of safe and responsible riding and of proper use and maintenance. Proper use and maintenance of your bicycle reduces risk of injury.

This Manual contains many “Warnings” and “Cautions” concerning the consequences of failure to maintain or inspect your bicycle and of failure to follow safe cycling practices.

- The combination of the  safety alert symbol and the word **WARNING** indicates a potentially hazardous situation which, if not avoided, could result in serious injury or death.
- The combination of the  safety alert symbol and the word **CAUTION** indicates a potentially hazardous situation which, if not avoided, may result in minor or moderate injury, or is an alert against unsafe practices.

- The word **CAUTION** used without the safety alert symbol indicates a situation which, if not avoided, could result in serious damage to the bicycle or the voiding of your warranty.

Many of the Warnings and Cautions say “you may lose control and fall”. Because any fall can result in serious injury or even death, we do not always repeat the warning of possible injury or death.

Because it is impossible to anticipate every situation or condition, which can occur while riding, this Manual makes no representation about the safe use of the bicycle under all conditions. There are risks associated with the use of any bicycle which cannot be predicted or avoided, and which are the sole responsibility of the rider.

A special note for parents:

As a parent or guardian, you are responsible for the activities and safety of your child, and that includes making sure that the bicycle is the right size and is properly fitted to the child; that it is in good repair and safe operating condition; that you and your child have learned and understand the safe operation of the bicycle; and that you and your child have learned, understand and obey not only the applicable local motor vehicle, bicycle and traffic laws, but also the common sense rules of safe and responsible bicycling. As a parent, you should read this manual, as well as review its warnings and the bicycle's functions and operating procedures with your child, before letting your child ride the bicycle. Children must be under adult supervision, whilst learning to ride. Once they can ride and are familiar with the bike, the appropriate level of supervision can only be the judgement of the parent. In making this judgement; you should consider the riding skills of the child, the risks associated with the riding conditions (e.g. traffic, wet, poor light, muddy, rough surfaces, etc.) and their experience in riding in those conditions.



WARNING: Make sure that your child always wears an approved bicycle helmet when riding; but also make sure that your child understands that a bicycle helmet is for bicycling only, and must be removed when not riding. A helmet must not be worn while playing, in play areas, on playground equipment, while climbing trees, or at any time while not riding a bicycle. Failure to follow this warning could result in serious injury or death.

1. First

NOTE: We strongly urge you to read this Manual in its entirety before your first ride. At the very least, read and make sure that you understand each point in this section, and refer to the cited sections on any issue which you don't completely understand. Please note that not all bicycles have all of the features described in this Manual. Ask your Halfords Bikehut store to point out the features of your bicycle.

A. Bike Fit

- 1 Is your bike the right size? To check, see Section 3.A. If your bicycle is too large or too small for you, you may lose control and fall. If your new bike is not the right size for you, do not ride it. Ask your Halfords Bikehut store to exchange it before you ride it.
- 2 Is the saddle at the right height? To check, see Section 3.B. If you adjust your saddle height, follow the Minimum Insertion instructions in Section 3.B.
- 3 Are saddle and seatpost securely clamped? A correctly tightened saddle will allow no saddle movement in any direction. See Section 3.B.
- 4 Are the stem and handlebars at the right height for you? If not, see Section 3.C.
- 5 Can you comfortably operate the brakes? If not, you may be able to adjust their angle and reach. See Section 3.D and 3.E.
- 6 Do you fully understand how to operate your new bicycle? If not, before your first ride, have your Halfords Bikehut store explain any functions or features which you do not understand.

B. Safety First

- 1 Always wear an approved helmet when riding your bike, and follow the helmet manufacturer's instructions for fit, use and care.
- 2 Do you have all the other required and recommended safety equipment? See Section 2. It's your responsibility to familiarize yourself with the laws of the areas where you ride, and to comply with all applicable laws.
- 3 Do you know how to correctly operate your wheel quick releases? Check Section 4.A.1 to make sure. Riding with an improperly adjusted wheel quick release can cause the wheel to wobble or disengage from the bicycle, and cause serious injury or death.
- 4 If your bike has toeclips and straps or clipless (SPD type) pedals, make sure you know how they work (see Section 4.E). These pedals require special techniques and skills. Follow the pedal manufacturer's instructions for use, adjustment and care.
- 5 Do you have "toe overlap"? On smaller framed bicycles your toe or toeclip may be able to contact the front wheel when a pedal is all the way forward and the wheel is turned. Read Section 4.E. to check whether you have toe overlap.
- 6 Does your bike have suspension? If so, check Section 4.F. Suspension can change the way a bicycle performs. Follow the suspension manufacturer's instructions for use, adjustment and care.

? Need assistance?

Ask your local Halfords Bikehut store

4

C. Mechanical Safety Check

Routinely check the condition of your bicycle before every ride.

Nuts, bolts, screws and other fasteners:

Because manufacturers use a wide variety of fastener sizes and shapes made in a range of materials, often differing by model and component, it is not possible for this Manual to specify the correct torque (tightening force) for all of the fasteners on your bicycle.

- a) Check if the component is marked with the recommended torque in the vicinity of the fastener (e.g. 10 Nm). If marked the fastener should be torqued tightened the marked torque value (in Nm).
- b) If the component is not marked with a recommended torque, use the tightening torque for the key safety parts that are listed below.

Fastener	Tightening Torque Nm
Front and rear wheel nuts	25 +/- 0.5
Handlebar to stem clamp bolts	15 +/- 0.5
Stem to fork steerer clamp bolts	17 +/- 0.5
Quill expander bolt	18 +/- 0.5
Saddle clamp to seat post (allen bolt clamp)	15 +/- 0.5
Saddle clamp to seat post (conventional bolt clamp)	20 +/- 0.5
Seat post to frame clamp (allen bolt clamp)	11 +/- 0.5
Seat post to frame clamp (conventional bolt clamp)	16 +/- 0.5
Any aerodynamic extensions (accessories)	As specified by the mfr.

If you choose to carry out further work on your own bicycle you must get the correct tightening torque specifications from the bicycle or component manufacturer or from your Halfords Bikehut store. If you need to make an adjustment at home or on a ride, we urge you to exercise care, and to have the fasteners you worked on checked by your Halfords Bikehut store as soon as possible.



WARNING: Correct tightening force on fasteners – nuts, bolts, screws – on your bicycle is important. Too little force, and the fastener may not hold securely. Too much force, and the fastener can strip threads, stretch, deform or break. Either way, incorrect tightening force can result in component failure, which can cause you to lose control and fall.

1 Everything Secure?

Make sure nothing is loose. Lift the front wheel off the ground by 50 to 75 mm (2 to 3"), then let it bounce on the ground. Anything sound, feel or look loose? Do a visual and tactile inspection of the whole bike. Any loose parts or accessories? If so, secure them. If you're not sure, ask someone with experience to check.



CAUTION - A bike has many moving parts, some with sharp edges (e.g. chain ring). Always be careful when riding or maintaining the bike to avoid injury or entrapment of your fingers, or any other part of your body.



CAUTION - the strength & stiffness of carbon fibre composite frames & components can be adversely affected by high temperatures. Do not keep the bike in poorly ventilated areas, where it is exposed to radiant heat sources.

2 Tyres And Wheels

Make sure tyres are correctly inflated (see Section 4.G.1). Check by putting one hand on the saddle, one on the intersection of the handlebars and stem, then bouncing your weight on the bike while looking at tyre deflection. Compare what you see with how it looks when you know the tyres are correctly inflated; and adjust if necessary.

Tyres in good shape? Spin each wheel slowly and look for cuts in the tread and sidewall. Replace damaged tyres before riding the bike.

Wheels true? Spin each wheel and check for brake clearance and side-to-side wobble. If a wheel wobbles side to side even slightly, or rubs against or hits the brake blocks, take the bike to a Halfords Bikehut store to have the wheel trued.

3 Brakes

Check the brakes for proper operation (see Section 4.C). squeeze the brake levers. Are the brake quick-releases closed? All control cables seated and securely engaged? Do the brake blocks contact the wheel rim squarely and make full contact with the rim? Do the brake blocks touch the wheel rim within 25 mm (1") of brake lever movement? Can you apply full braking force at the levers without having them touch the handlebar? If not, your brakes need adjustment.

Minor adjustments can be made using the threaded cable adjusters at the brake levers. If this is insufficient, the cable clamp at the brake lever may need to be moved or there could be some other fault.

Do not ride the bike until the brakes are properly adjusted by a professional bicycle mechanic.

4 Quick Releases

Make sure the front wheel, rear wheel and seat post quick releases are properly adjusted and in the locked position. See Section 4.A and 4.B.



CAUTION: Wheels must be true for the brakes to work effectively. Wheel truing is a skill, which requires special tools and experience. Do not attempt to true a wheel unless you have the knowledge, experience and tools needed to do the job correctly.

Wheel rims clean and undamaged? Make sure the rims are clean and undamaged along the braking surface, and check for excess rim wear (see Section 4.C).

5 Handlebar And Saddle Alignment

Make sure the saddle and handlebar stem are parallel to the bike's centre line and clamped tight enough so that you can't twist them out of alignment. See Sections 3.B and 3.C.

6 Handlebar Ends

Make sure the handlebar grips are secure and in good condition. If not, have your Halfords Bikehut store replace them. Make sure the handlebar ends and extensions are plugged. If not, have your Halfords Bikehut store plug them before you ride. If the handlebars have bar end extensions, make sure they are clamped tight enough so you can't twist them.



WARNING: Loose or damaged handlebar grips or extensions can cause you to lose control and fall. Unplugged handlebars or extensions can cut you and cause serious injury in an otherwise minor accident.

VERY IMPORTANT SAFETY NOTE: Please also read and become thoroughly familiar with the important information on the lifespan of your bicycle and its components in Appendix A on Page 35.

? Need assistance?

Ask your local Halfords Bikehut store

D. First Ride

When you buckle on your helmet and go for your first familiarisation ride on your new bicycle, be sure to pick a controlled environment, away from cars, other cyclists, obstacles or other hazards. Ride to become familiar with the controls, features and performance of your new bike.

Familiarise yourself with the braking action of the bike (see Section 4.C). The right hand brake lever operates the front brake and the left, the rear. Test the brakes at slow speed, putting your weight toward the rear and gently applying the brakes, rear brake first. Sudden or excessive application of the front brake could pitch you over the handlebars. Applying brakes too hard can lock up a wheel, which could cause you to lose control and fall. Skidding is an example of what can happen when a wheel locks up.

The braking performance of a new bike may improve if you complete the brake blocks and pads 'bedding in' procedure described in Section 4.C.4

If your bicycle has toeclips or clipless pedals, practice getting in and out of the pedals (see paragraph B.4 above and Section 4.E.4).

If your bike has suspension, familiarise yourself with how the suspension responds to brake application and rider weight shifts (see paragraph B.6 above and Section 4.F).

Practice shifting the gears (see Section 4.D). Remember never move the shifter whilst stationary, whilst pedalling backwards, or pedal backwards immediately after having moved the shifter. This could jam the chain and cause serious damage to the bicycle.

Check out the handling and response of the bike; and check the comfort.

If you have any questions, or if you feel anything about the bike is not as it should be, consult your Halfords Bikehut store before your next ride.

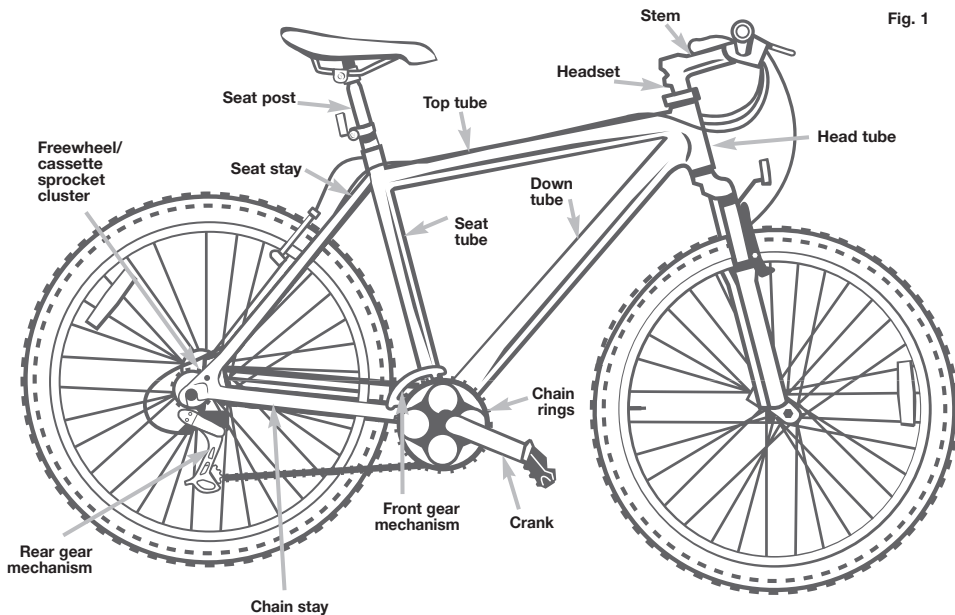

Fig. 1

2. Safety

A. The Basics



WARNING: Observe all local bicycle laws and regulations. Observe regulations about bicycle lighting, riding on pavements, laws regulating bike path and trail use, helmet laws, child carrier laws, special bicycle traffic laws. It's your responsibility to know and obey the laws.

- 1 Always wear a cycling helmet which meets the latest certification standards and is appropriate for the type of riding you do. Always follow the helmet manufacturer's instructions for fit, use and care of your helmet. Most serious bicycle injuries involve head injuries, which might have been avoided if the rider had worn an appropriate helmet. A cycle ridden on public roads during daylight hours should be fitted with reflectors (front, rear, pedals and wheels) and have a bell.



WARNING: Failure to wear a helmet when riding may result in serious injury or death.

- 2 Always do the Mechanical Safety Check (Section 1.C) before you get on a bike.
- 3 Be thoroughly familiar with the controls of your bicycle: brakes (Section 4.C.), pedals (Section 4.E.), gear shifting (Section 4.D.).
- 4 Be careful to keep body parts and other objects away from the sharp teeth of chainrings, the moving chain, the turning pedals and cranks, and the spinning wheels of your bicycle.
- 5 Always wear:
 - Shoes that will stay on your feet and will grip the pedals. Make sure that shoe laces cannot get into moving parts, and never ride barefoot or in sandals.
 - Bright, visible clothing that is not so loose that it can be tangled in the bicycle or snagged by objects at the side of the road or trail.
 - Protective eyewear, to protect against airborne dirt, dust and bugs – tinted when the sun is bright, clear when it's not.

- 6 Don't jump with your bike. Jumping a bike, particularly a BMX or mountain bike, can be fun; but it can put huge and unpredictable stress on the bicycle and its components. Riders who insist on jumping their bikes risk serious damage, to their bicycles as well as to themselves. Before you attempt to jump, do stunt riding or race with your bike, read and understand Section 2.F.
- 7 Ride at a speed appropriate for conditions. Increased speed means higher risk.

? Need assistance?

Ask your local Halfords Bikehut store

B. Riding Safety

- 1 You are sharing the road or the path with others – motorists, pedestrians and other cyclists. Respect their rights.
- 2 Ride defensively. Always assume that others do not see you.
- 3 Look ahead, and be ready to avoid:
 - Vehicles slowing or turning, entering the road or your lane ahead of you, or coming up behind you.
 - Parked car doors opening.
 - Pedestrians stepping out.
 - Children or pets playing near the road.
 - Pot holes, drain gratings, tram tracks, expansion joints, road or pavement construction, debris and other obstructions that could cause you to swerve into traffic, catch your wheel or cause you to have an accident.
 - The many other hazards and distractions which can occur on a bicycle ride.
- 4 Ride in designated bike lanes, on designated bike paths or as close to the edge of the road as possible, in the direction of traffic flow or as directed by local laws.
- 5 Stop at stop signs and traffic lights; slow down and look both ways at road junctions. Remember that a bicycle always loses in a collision with a motor vehicle; so be prepared to yield even if you have the right of way.
- 6 Use approved hand signals for turning and stopping.
- 7 Never ride with headphones. They mask traffic sounds and emergency vehicle sirens, distract you from concentrating on what's going on around you, and their wires can tangle in the moving parts of the bicycle, causing you to lose control.
- 8 Never carry a passenger, unless it is a small child wearing an approved helmet and secured in a correctly mounted child carrier or a child-carrying trailer. When carrying a child in a child seat, ensure that any saddle coil springs are covered to eliminate the possibility of the child's fingers becoming trapped.
- 9 Never carry anything which obstructs your vision or your complete control of the bicycle, or which could become entangled in the moving parts of the bicycle.
- 10 Never hitch a ride by holding on to another vehicle.
- 11 Don't do stunts, wheelies or jumps. If you intend to do stunts, wheelies, jumps or go racing with your bike read Section 2.F, *Downhill, Stunt or Competition Riding*, **now**. Think carefully about your skills before deciding to take the significant risks that go with this kind of riding.
- 12 Don't weave through traffic or make any moves that may surprise the people with whom you are sharing the road.
- 13 Observe and yield the right of way.
- 14 Never ride your bicycle while under the influence of alcohol or drugs.
- 15 If possible, avoid riding in bad weather, when visibility is obscured, at dawn, dusk or in the dark, or when extremely tired. Each of these conditions increases the risk of accident.

C. Off Road Safety

We recommend that children do not ride on rough terrain unless they are accompanied by an adult.

- 1 The variable conditions and hazards of off-road riding require close attention and specific skills. Start slowly on easier terrain and build up your skills. If your bike has suspension, the increased speed you may develop also increases your risk of losing control and falling. Get to know how to handle your bike safely before trying increased speed or more difficult terrain.
- 2 Wear safety gear appropriate to the kind of riding you plan to do.
- 3 Don't ride alone in remote areas. Even when riding with others, make sure that someone knows where you're going and when you expect to be back.
- 4 Always take along some kind of identification, so that people know who you are in case of an accident; and take along a some cash for a snack, a cool drink or an emergency phone call.

5 Yield right of way to pedestrians and animals. Ride in a way that does not frighten or endanger them, and give them enough room so that their unexpected moves don't endanger you.

6 Be prepared. If something goes wrong while you're riding off-road, help may not be close.

7 Before you attempt to jump, do stunt riding or race with your bike, read and understand Section 2.F.

Off Road respect

Obey the local laws regulating where and how you can ride off road, and respect private property. You may be sharing the trail with others – hikers, equestrians, other cyclists. Respect their rights. Stay on the designated trail. Don't contribute to erosion by riding in mud or with unnecessary sliding. Don't disturb the ecosystem by cutting your own trail or take a shortcut through vegetation or streams. It is your responsibility to minimise your impact on the environment. Leave things as you found them; and always take out everything you brought in.

D. Wet Weather Riding



WARNING: Wet weather impairs traction, braking and visibility, both for the cyclist and for other vehicles sharing the road. The risk of an accident is dramatically increased in wet conditions.

Under wet conditions, the stopping power of your brakes (as well as the brakes of other vehicles sharing the road) is dramatically reduced and your tyres don't grip nearly as well. This makes it harder to control speed and easier to lose control. To make sure that you can slow down and stop safely in wet conditions, ride more slowly and apply your brakes earlier and more gradually than you would under normal, dry conditions (see also Section 4.C).

? Need assistance?

Ask your local Halfords Bikehut store

10

E. Night Riding

Riding a bicycle at night is many times more dangerous than riding during the day. A cyclist is very difficult for motorists and pedestrians to see. Therefore, children should never ride at dawn, at dusk or at night.

Adults who choose to accept the greatly increased risk of riding at dawn, at dusk or at night need to take extra care both riding and choosing specialised equipment, which helps reduce that risk. Consult your Halfords Bikehut store about night riding safety equipment.



WARNING: Reflectors are not a substitute for required lights. Riding at dawn, at dusk, at night or at other times of poor visibility without an adequate bicycle lighting system and without reflectors is dangerous and may result in serious injury or death.

Bicycle reflectors are designed to pick up and reflect car lights and street lights in a way that may help you to be seen and recognized as a moving cyclist.



CAUTION: Check reflectors and their mounting brackets regularly to make sure that they are clean, straight, unbroken and securely mounted. Have your Halfords Bikehut store replace damaged reflectors and straighten or tighten any that are bent or loose.



WARNING: Do not remove the front or rear reflectors or reflector brackets from your bicycle. They are an integral part of the bicycle's safety system. Removing the reflectors may reduce your visibility to others using the roadway. Being struck by other vehicles may result in serious injury or death. The reflector brackets may protect you from the brake straddle cable catching on the tyre in the event of brake cable failure. If a brake straddle cable catches on the tyre, it can cause the wheel to stop suddenly, causing you to lose control and fall.

If you choose to ride under conditions of poor visibility, check and be sure you comply with all local laws about night riding, and take the following strongly recommended additional precautions:

- Purchase and install battery powered front and rear lights, which meet all regulatory requirements and provide adequate visibility.

In the UK white front and red rear lights must be fitted, which either comply with BS 6102 - 3 or are flashing LED lights with a light output of more than 4 candela and a flashing rate of between 1 and 4 times per second. It is recommended that flashing LED lights are used in conjunction with a steady light, when riding on unlit roads.

In the Republic of Ireland you must show a white or yellow front light and a red rear light. The rear light should be visible from a distance of at least 152m (500 ft).

- Wear light coloured, reflective clothing and accessories, such as a reflective vest, reflective arm and leg bands, flashing LED lights attached to your body and/or your bicycle – any reflective device or light source that moves will help you get the attention of approaching motorists, pedestrians and other traffic.
- Make sure your clothing or anything you may be carrying on the bicycle does not obstruct a reflector or light.
- Make sure that your bicycle is equipped with correctly positioned and securely mounted reflectors.

While riding at dawn, at dusk or at night:

- Ride slowly.
- Avoid dark areas and areas of heavy or fast-moving traffic.
- Avoid road hazards.
- If possible, ride on familiar routes.

When riding in traffic:

- Be predictable. Ride so that drivers can see you and predict your movements.
- Be alert. Ride defensively and expect the unexpected.
- If you plan to ride in traffic often, ask your Halfords Bikehut store about traffic safety classes or a good book on bicycle traffic safety.

F. Extreme, Stunt Or Competition Riding

Whether you call it *Aggro*, *Freeride*, *North Shore*, *Downhill*, *Jumping*, *Stunt Riding*, *Racing* or something else; by engaging in this sort of extreme, aggressive riding you are accepting an increased risk of injury or death. Not all bicycles are designed for these types of riding, and those that are may not be suitable for all types of aggressive riding. Check with your Halfords Bikehut store or the bicycle's manufacturer about the suitability of your bicycle before engaging in any type of extreme riding.

When riding fast down hill, you can reach speeds seen on motorcycles, and therefore face similar hazards and risks. Have your bicycle and equipment carefully inspected by a qualified mechanic and be sure it is in perfect condition. Consult with expert riders and race officials on conditions and equipment advisable at the site where you plan to ride.

Wear appropriate safety gear, including an approved full face helmet, full finger gloves, and body armour. Ultimately, it is your responsibility to have proper equipment and to be familiar with course conditions.



WARNING: Although many magazines, advertisements and articles about cycling depict riders engaged in extreme riding, this activity is extremely dangerous, increases your risk of injury or death, and increases the severity of any injury. Remember that the action depicted is being performed by professionals with many years of training and experience.

Know your limits and always wear a helmet and other appropriate safety gear. Even with state-of-the-art protective safety gear, you could be seriously injured or killed when jumping, stunt riding, riding downhill at speed or in competition.



CAUTION: Bicycles and bicycle parts have limitations with regard to strength and integrity, and this type of riding can exceed those limitations.

We strongly recommend against this type of riding because of the increased risks; but if you choose to take the risk, at least:

- Take lessons from a competent instructor first
- Start with easy learning exercises and slowly develop your skills before trying more difficult or dangerous riding
- Do stunts, jumping, racing or fast downhill riding only in areas designated for this type of riding
- Wear a full face helmet, safety pads and other safety gear
- Understand and recognize that the stresses imposed on your bike by this kind of activity may break or damage parts of the bicycle and void the warranty
- Take your bicycle to your Halfords Bikehut store if anything breaks or bends. Do not ride your bicycle when any part is damaged.

If you ride downhill at speed, do stunt riding or ride in competition, know the limits of your skill and experience. Ultimately, avoiding injury is your responsibility.

? Need assistance?

Ask your local Halfords Bikehut store

12

G. Changing Components Or Adding Accessories

There are many components and accessories available to enhance the comfort, performance and appearance of your bicycle. However, if you change components or add accessories, you do so at your own risk. The bicycle's manufacturer may not have tested that component or accessory for compatibility, reliability or safety on your bicycle. Almost every component used on a cycle has safety related features; always only use genuine replacement parts. This is particularly important for the safety critical areas of braking, steering, wheels and tyres. The addition of any aerodynamic extensions may adversely affect the cycle's response to steering and braking.

Before installing any component or accessory, including a different size tyre, make sure that it is compatible with your bicycle by checking with your Halfords Bikehut store. Be sure to read, understand and follow the instructions that accompany the products you purchase for your bicycle (See also Appendix A p. 35).



WARNING: Failure to confirm compatibility, properly install, operate and maintain any component or accessory can result in serious injury or death.



CAUTION: Changing the components on your bike may void the warranty. Refer to your warranty, and check with your Halfords Bikehut store before changing the components on your bike.



CAUTION: If you fit a rear mount child cycle seat to your bike. Always ensure that any under saddle coil springs are covered to prevent any risk of finger entrapment for the child.

3. Fit

NOTE: Correct fit is an essential element for safety, performance and comfort. Making the adjustments to your bicycle, which result in correct fit for your body and riding conditions requires experience, skill and special tools. Always have your Halfords Bikehut store make the adjustments on your bicycle; or, if you have the experience, skill and tools, have your Halfords Bikehut store check your work before riding.



WARNING: If your bicycle does not fit properly, you may lose control and fall. If your new bike doesn't fit, ask your Halfords Bikehut store to exchange it before you ride it.

A. Standover Height

Standover height is the basic element of bike fit (see fig. 2). It is the distance from the ground to the top of the bicycle's frame at that point where your crotch is when straddling the bike.

To check for correct standover height, straddle the bike while wearing the kind of shoes in which you'll be riding, and bounce vigorously on your heels. If your crotch touches the frame, the bike is too big for you. Don't even ride the bike around the corner. A bike should give you a minimum standover height clearance of two inches (50 mm).

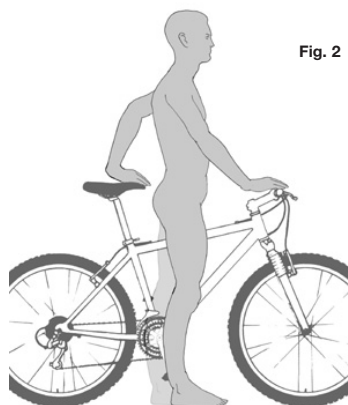

Fig. 2



WARNING: If you plan to use your bike for jumping or stunt riding, read Section 2.F again.



Need assistance?

Ask your local Halfords Bikehut store

B. Saddle Position

Correct saddle adjustment is an important factor in getting the most performance and comfort from your bicycle. If the saddle position is not comfortable for you, see your Halfords Bikehut store.

The saddle can be adjusted in three directions:

- 1 Up and down adjustment. To check for correct saddle height (fig. 3):
 - sit on the saddle;
 - place one heel on a pedal;
 - rotate the crank until the pedal with your heel on it is in the down position and the crank arm is parallel to the seat tube.

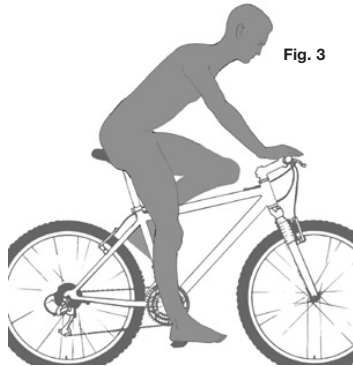

Fig. 3

If your leg is not completely straight, your saddle height needs to be adjusted. If your hips must rock for the heel to reach the pedal, the saddle is too high. If your leg is bent at the knee with your heel on the pedal, the saddle is too low.

Once the saddle is at the correct height, make sure that the seatpost does not project from the frame beyond its "Minimum Insertion" mark (fig. 4).

If your bike has an interrupted seat tube, as is the case on some bikes with rear suspension, you must also make sure that the seat post is far enough into the frame so that you can touch it through the bottom of the interrupted seat tube with the tip of your finger, without inserting your finger beyond its first knuckle (see fig. 5). Ensure that any seat post projecting from the interrupted seat tube does not interfere with the free movement of the rear suspension.

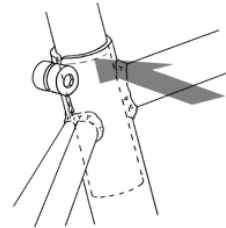

Fig. 4

WARNING: If your seat post projects from the frame beyond the Minimum Insertion mark (see fig. 4) or you cannot touch the bottom of the seat post through the bottom of the interrupted seat tube with the tip of your finger without inserting your finger beyond its first knuckle (see fig. 5), the seat post may break, which could cause you to lose control and fall.

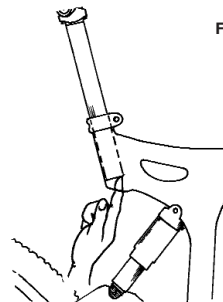

Fig. 5

- 2 Front and back adjustment. The saddle can be adjusted forward or back to help you get the optimal position on the bike. Ask your Halfords Bikehut store to set the saddle for your optimal riding position and to show you how to make this adjustment.
- 3 Saddle angle adjustment. Most people prefer a horizontal saddle; but some riders like the saddle nose angled up or down very slightly. Your Halfords Bikehut store can adjust saddle angle or teach you how to do it.

The minimum saddle height varies for each model, it is achieved by putting the seat post at its lowest position and is measured from the ground to the middle of the upper surface of the saddle

Note: If your bicycle is equipped with a suspension seat post, periodically ask your Halfords Bikehut store to check it.

Small changes in saddle position can have a substantial effect on performance and comfort. To find your best saddle position, make only one adjustment at a time.



WARNING: After any saddle adjustment, be sure that the saddle adjusting mechanism is properly tightened before riding. A loose saddle clamp or seat post binder can cause damage to the seat post, or can cause you to lose control and fall. A correctly tightened saddle adjusting mechanism will allow no saddle movement in any direction. Periodically check to make sure that the saddle adjusting mechanism is properly tightened.

If, in spite of carefully adjusting the saddle height, tilt and fore-and aft position, your saddle is still uncomfortable, you may need a different saddle design. Saddles, like people, come in many different shapes, sizes and resilience. Your Halfords Bikehut store can help you select a saddle which, when correctly adjusted for your body and riding style, will be comfortable.



WARNING: Some people have claimed that extended riding with a saddle which is incorrectly adjusted or which does not support your pelvic area correctly can cause short-term or long-term injury to nerves and blood vessels, or even impotence. If your saddle causes you pain, numbness or other discomfort, listen to your body and stop riding until you see your Halfords Bikehut store about saddle adjustment or a different saddle.

? Need assistance?

Ask your local Halfords Bikehut store

C. Handlebar Height And Angle

Your bike is equipped either with a “threadless” stem, which clamps on to the outside of the steerer tube, or with a “quill” stem, which clamps inside the steerer tube by way of an expanding binder bolt. If you aren’t absolutely sure which type of stem your bike has, ask your Halfords Bikehut store.

If your bike has a “threadless” stem (fig. 6), your Halfords Bikehut store may be able to change handlebar height by moving height adjustment spacers from below the stem to above the stem, or vice versa. Otherwise, you’ll have to get a stem of different length or rise. Consult your Halfords Bikehut store. Do not attempt to do this yourself, as it requires special knowledge.

If your bike has a “quill” stem (fig. 7), you can ask your Halfords Bikehut store to adjust the handlebar height a bit by adjusting stem height. A quill stem has an etched or stamped mark on its shaft, which designates the stem’s “Minimum Insertion”. This mark must not be visible above the headset.



WARNING: On some bicycles, changing the stem or stem height can affect the tension of the front brake cable, locking the front brake or creating excess cable slack, which can make the front brake inoperable. If the front brake blocks move in towards the wheel rim or out away from the wheel rim when the stem or stem height is changed, the brakes must be correctly adjusted before you ride the bicycle.



WARNING: The stem’s Minimum Insertion Mark must not be visible above the top of the headset. If the stem is extended beyond the Minimum Insertion Mark the stem may break or damage the fork’s steerer tube, which could cause you to lose control and fall.

Your Halfords Bikehut store can also change the angle of the handlebar or any bar end extensions.



WARNING: An insufficiently tightened stem binder bolt, handlebar binder bolt or bar end extension clamping bolt may compromise the steering action, which could cause you to lose control and fall. Place the front wheel of the bicycle between your legs and attempt to twist the handlebar/stem assembly. If you can twist the stem in relation to the front wheel, turn the handlebars in relation to the stem, or turn the bar end extensions in relation to the handlebar, the bolts are insufficiently tightened.

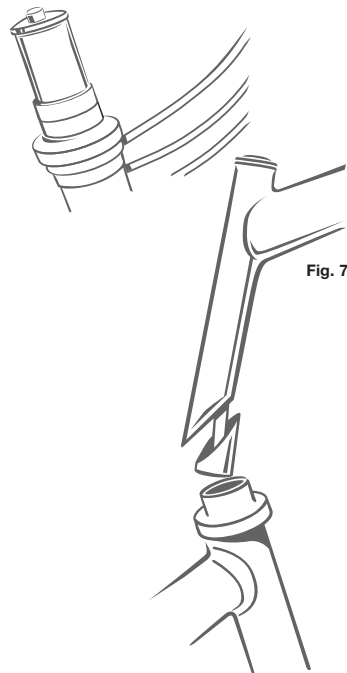
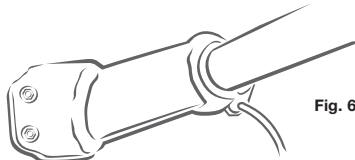

D. Control Position Adjustments

The angle of the brake and shift control levers and their position on the handlebars can be changed. Ask your Halfords Bikehut store to make the adjustments for you.

E. Brake Reach

Many bikes have brake levers, which can be adjusted for reach. If you have small hands or find it difficult to squeeze the brake levers, your Halfords Bikehut store can either adjust the reach or fit shorter reach brake levers.



WARNING: The shorter the brake lever reach, the more critical it is to have correctly adjusted brakes, so that full braking power can be applied within available brake lever travel. Brake lever travel insufficient to apply full braking power can result in loss of control, which may result in serious injury or death.

? Need assistance?

Ask your local Halfords Bikehut store

18

4. Technical

It's important to your safety, performance and enjoyment to understand how things work on your bicycle. We urge you to ask your Halfords Bikehut store how to do the things described in this section before you attempt them yourself, and that you have your Halfords Bikehut store check your work before you ride the bike. If you have even the slightest doubt as to whether you understand something in this section of the Manual, talk to your Halfords Bikehut store (See also Appendix A p. 35).

A. Wheels

NOTE: If you have a bike equipped with quick release axles on the front or rear wheels, make sure that your Halfords Bikehut store has given you the manufacturer's instructions, and follow those when installing or removing a quick release axle wheel. If you don't know what a quick release axle is, ask your Halfords Bikehut store.

1 Wheel Quick Release



WARNING: Riding with an improperly adjusted wheel quick release can allow the wheel to wobble or fall off the bicycle, which can cause serious injury or death. Therefore, it is essential that you:

- 1 Ask your Halfords Bikehut store to help you make sure you know how to install and remove your wheels safely.

- 2 Understand and apply the correct technique for clamping your wheel in place with a quick release.

- 3 Each time, before you ride the bike, check that the wheel is securely clamped (see fig. 8).

A wheel quick release uses a cam action to clamp the bike's wheel in place (see fig. 8). Because of its adjustable nature, it is critical that you understand how it works, how to use it properly, and how much force you need to apply to secure the wheel.



WARNING: The full force of the cam action is needed to clamp the wheel securely. Holding the nut with one hand and turning the lever like a wing nut with the other hand until everything is as tight as you can get it will not clamp the wheel safely in the dropouts.

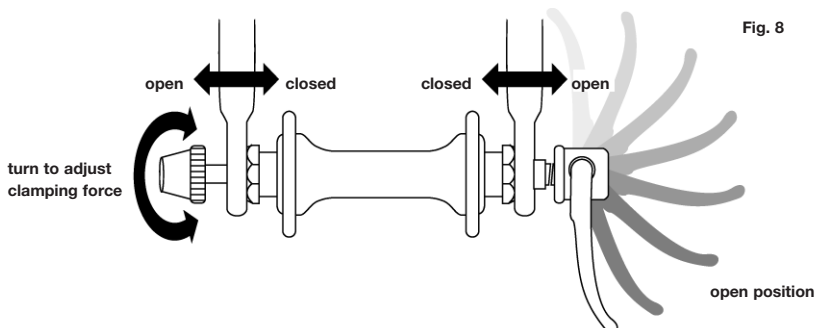

a. Adjusting The Quick Release Mechanism

The wheel hub is clamped in place by the force of the quick release cam pushing against one dropout and pulling the tension-adjusting nut, by way of the skewer, against the other dropout. The amount of clamping force is controlled by the tension-adjusting nut. Turning the tension-adjusting nut clockwise whilst keeping the cam lever from rotating increases clamping force; turning it anticlockwise whilst keeping the cam lever from rotating reduces clamping force. Less than half a turn of the tension-adjusting nut can make the difference between safe clamping force and unsafe clamping force.

b. Front Wheel Secondary Retention Devices

Most bicycles have front forks, which utilize a secondary wheel retention device to reduce the risk of the wheel disengaging from the fork if the quick release is incorrectly adjusted. Secondary retention devices are not a substitute for correct quick release adjustment. Secondary retention devices fall into two basic categories:

- 1 The clip-on type is an oval washer with a tab, (fig. 9) which the manufacturer adds to the front wheel hub. The tabs must be located in the holes or slots at the ends of the fork legs, before tightening the wheel nuts.
- 2 The integral type is a recess that is moulded, cast or machined into the outer faces of the front fork dropouts.

Ask your Halfords Bikehut store to explain the particular secondary retention device on your bike.



WARNING: Do not remove or disable the secondary retention device. As its name implies, it serves as a back up for a critical adjustment. If the quick release is not adjusted correctly, the secondary retention device can reduce the risk of the wheel disengaging from the fork. Removing or disabling the secondary retention device may also void the warranty.

Secondary retention devices are not a substitute for correct quick release adjustment. Failure to properly adjust the quick release mechanism can cause the wheel to wobble or disengage, which could cause you to lose control and fall, resulting in serious injury or death.

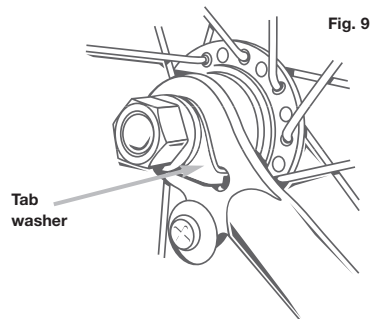

2 Removing And Installing Quick Release Wheels

a. Removing A Quick Release Front Wheel



CAUTION: If your bike has a disc front brake, exercise care in touching it. Discs have sharp edges and can get very hot during use.

- 1 If your bike has rim brakes, disengage the brake's quick-release mechanism to increase the clearance between the tyre and brake blocks (See Section 4.C fig.14 through to 18).
- 2 Move the wheel's quick-release lever from the locked or CLOSED position to the OPEN position (figs. 10a & b).
- 3 If your front fork does not have a secondary retention device go to step (5).

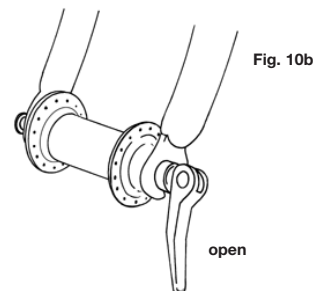
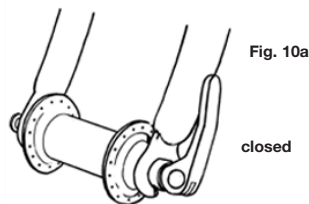

? Need assistance?

Ask your local Halfords Bikehut store

20

- 4 If your front fork has a clip-on type secondary retention device, disengage it and go to step (5). If your front fork has an integral secondary retention device, loosen the tension-adjusting nut enough to allow removal of the wheel; then go to the next step.
- 5 Raise the front wheel a few inches off the ground and tap the top of the wheel with the palm of your hand to release the wheel from the front fork.
- 5 If the lever cannot be pushed all the way to a position parallel to the fork blade, return the lever to the OPEN position. Then turn the tension adjusting nut anticlockwise one-quarter turn and try tightening the lever again.
- 6 Re-engage the brake quick-release mechanism to restore correct brake block-to-rim clearance; spin the wheel to make sure that it is centered in the frame and clears the brake blocks; then squeeze the brake lever and make sure that the brakes are operating correctly.

b. Installing A Quick Release Front Wheel



CAUTION: If your bike is equipped with disc brakes, be careful not to damage the disc, caliper or brake pads when re-inserting the disc into the caliper. Never activate a disc brake's control lever unless the disc is correctly inserted in the caliper. See also Section 4.C.

- 1 Move the quick-release lever so that it curves away from the wheel (fig. 10b). This is the OPEN position.
- 2 With the steering fork facing forward, insert the wheel between the fork blades so that the axle seats firmly at the top of the slots, which are at the tips of the fork blades – the fork dropouts. The quick-release lever should be on the left side of the bicycle (fig.10a & b). If your bike has a clip-on type secondary retention device, engage it.
- 3 Holding the quick-release lever in the OPEN position with your right hand, tighten the tension adjusting nut with your left hand until it is finger tight against the fork dropout (fig. 8).
- 4 While pushing the wheel firmly to the top of the slots in the fork dropouts, and at the same time centering the wheel rim in the fork, move the quick-release lever upwards and swing it into the CLOSED position (fig. 8 & 10a). The lever should now be parallel to the fork blade and curved toward the wheel. To apply enough clamping force, you should have to wrap your fingers around the fork blade for leverage, and the lever should leave a clear imprint in the palm of your hand.



WARNING: Securely clamping the wheel takes considerable force. If you can fully close the quick release without wrapping your fingers around the fork blade for leverage, and the lever does not leave a clear imprint in the palm of your hand, the tension is insufficient. Open the lever; turn the tension-adjusting nut clockwise a quarter turn; then try again.

c. Removing A Quick Release Rear Wheel

- 1 Shift the rear derailleur to high gear (the smallest, outermost rear sprocket).
- 2 If your bike has rim brakes, disengage the brake's quick-release mechanism to increase the clearance between the wheel rim and the brake blocks (see Section 4.C, figs. 14 through to 18).
- 3 Pull the derailleur body back with your right hand.
- 4 Move the quick-release lever to the OPEN position (fig. 10b).
- 5 Lift the rear wheel off the ground a few inches and, with the derailleur still pulled back, push the wheel forward and down until it comes out of the rear dropouts.

Fig. 11

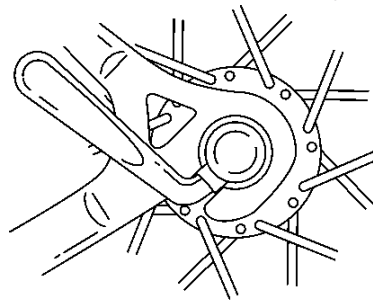

Wheel in dropouts

d. Installing A Quick Release Rear Wheel

NOTE: If your bike is equipped with disc brakes, be careful not to damage the disc, caliper or brake pads when re-inserting the disc into the caliper. Never activate a disc brake's control lever unless the disc is correctly inserted in the caliper.

- 1 Make sure that the rear derailleur is still in its outermost, high gear, position
- 2 Pull the derailleur body back with your right hand.
- 3 Move the quick-release lever to the OPEN position (see fig. 8). The lever should be on the side of the wheel opposite the derailleur and freewheel sprockets.
- 4 Put the chain on top of the smallest freewheel sprocket. Then, insert the wheel up and back into the frame dropouts and pull it all the way in to the dropouts.
- 5 Tighten the quick-release adjusting nut until it is finger tight against the frame dropout; then swing the lever toward the front of the bike until it is parallel to the frame's chain stay or seat stay and is curved toward the wheel (fig. 10a & fig. 11). To apply enough clamping force, you should have to wrap your fingers around a frame tube for leverage, and the lever should leave a clear imprint in the palm of your hand.



WARNING: Securely clamping the wheel takes considerable force. If you can fully close the quick release without wrapping your fingers around the seat stay or chain stay for leverage, and the lever does not leave a clear imprint in the palm of your hand, the tension is insufficient. Open the lever; turn the tension-adjusting nut clockwise a quarter turn; then try again.

The rear wheel must be secured to the bicycle frame with sufficient force so that it cannot be pulled forward by the chain, even under the greatest pedaling force. If the wheel moves under pedaling force, the tyre can touch the frame, which can cause you to lose control and fall.

- 6 If the lever cannot be pushed all the way to a position parallel to the chain stay or seat stay tube, return the lever to the OPEN position. Then turn the adjusting nut anticlockwise one-quarter turn and try tightening again.
- 7 Push the rear derailleur back into position.
- 8 Re-engage the brake quick-release mechanism to restore correct brake block-to-rim clearance; spin the wheel to make sure that it is centered in the frame and clears the brake blocks; then squeeze the brake lever and make sure that the brakes are operating correctly.

? Need assistance?

Ask your local Halfords Bikehut store

22

3 Removing And Installing Bolt-On Wheels

a. Removing A Bolt-On Front Wheel

- 1 If your bike has rim brakes, disengage the brake's quick-release mechanism to increase the clearance between the tyre and the brake blocks (see Section 4.C, figs. 14 through to 18).
- 2 Using a correct size spanner, loosen the two axle nuts.
- 3 If your front fork has a clip-on type secondary retention device, disengage it and go to the next step. If your front fork has an integral secondary retention device, loosen the axle nuts enough to allow wheel removal; then go to the next step.
- 4 Raise the front wheel a few inches off the ground and tap the top of the wheel with the palm of your hand to knock the wheel out of the fork ends.

b. Installing A Bolt-On Front Wheel

- 1 With the steering fork facing forward, insert the wheel between the fork blades so that the axle seats firmly at the top of the slots, which are at the tips of the fork blades. The axle nut washers should be on the outside, between the fork blade and the axle nut. If your bike has a clip-on type tab washer secondary retention device, engage it (see Section 4.A 1b).
- 2 While pushing the wheel firmly to the top of the slots in the fork dropouts, and at the same time centering the wheel rim in the fork, use the correct size spanner to tighten the axle nuts enough so that the wheel stays in place; then use a spanner on each nut simultaneously to fully tighten the nuts.
- 3 Re-engage the brake quick-release mechanism to restore correct brake block-to-rim clearance; spin the wheel to make sure that it is centered in the frame and clears the brake blocks; then squeeze the brake lever and make sure that the brakes are operating correctly.

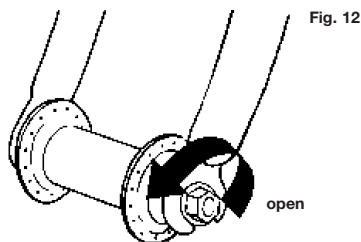

Fig. 12

c. Removing A Bolt-On Rear Wheel

Warning **WARNING: If your bike is equipped with an internal gear rear hub, do not attempt to remove the rear wheel. The removal and re-installation of internal gear hubs require special knowledge. Incorrect removal or assembly can result in hub failure, which can cause you to lose control and fall.**

- 1 If your bike has rim brakes, disengage the brake's quick-release mechanism to open the clearance between the tyre and the brake blocks (see Section 4.C, figs. 14 through to 18).
- 2 Shift the rear derailleur to high gear (the smallest rear sprocket) and pull the derailleur body back with your right hand.
- 3 Using the correct size spanner, loosen the two axle nuts.
- 4 Lift the rear wheel off the ground a few inches and, with the derailleur still pulled back, push the wheel forward and down until it comes out of the rear dropouts.

d. Installing A Bolt-On Rear Wheel

- 1 Shift the rear derailleur to its outermost position and pull the derailleur body back with your right hand.
- 2 Put the chain on to the smallest sprocket. Then, insert the wheel into the frame dropouts and pull it up and back completely in to the dropouts. The axle nut washers should be on the outside, between the frame and the axle nut.
- 3 Using the correct size spanner, tighten the axle nuts enough so that the wheel stays in place; then use a spanner on each nut simultaneously to fully tighten the nuts.
- 4 Push the rear derailleur back into position.
- 5 Re-engage the brake quick-release mechanism to restore correct brake block-to-rim clearance; spin the wheel to make sure that it is centered in the frame and clears the brake blocks; then squeeze the brake lever and make sure that the brakes are operating correctly.

e. Chain Tension Single Speed Cycles

- 1 Finger tighten both axle nuts. Pull the wheel backwards, ensuring that it is centralized and that there is approximately 12mm (1/2") of play in the chain. Check the play at the mid point of the chain between the chain ring and the rear sprocket.
- 2 Use a spanner on each nut simultaneously to fully tighten the nuts.
- 3 Turn the cranks through at least one full revolution and check that eccentricity does not cause the chain to become too taut at any point.

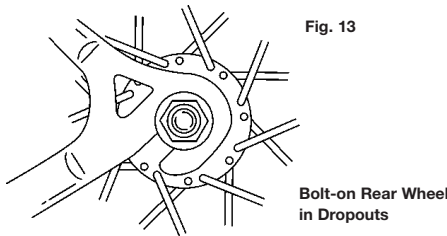

f. Chain Tension Hub Geared Cycles

- 1 This bike is fitted with an eccentric bottom bracket. If the chain tension needs adjustment, loosen the two pinch bolts at the bottom bracket and rotate it until there is approximately 12mm (1/2") of play in the chain. Check the play at the mid point of the chain ring and the rear sprocket. Ensure that the two pinch bolts are securely tightened to lock the bottom bracket in position.
- 2 Turn the cranks through at least one full revolution and check that eccentricity does not cause the chain to become too taut at any point.

B. Seat Post Quick Release

Some bikes are equipped with a quick-release seat post binder. The seat post quick-release binder works exactly like the wheel quick-release (Section 4.A.1) While a quick release looks like a long bolt with a lever on one end and a nut on the other, the quick release uses a cam action to firmly clamp the seat post (see fig. 8).



WARNING: Riding with an improperly tightened seat post can allow the saddle to turn or move and cause you to lose control and fall. Therefore:

- 1 Ask your Halfords Bikehut store to help you make sure you know how to correctly clamp your seat post.
- 2 Understand and apply the correct technique for clamping your seat post quick release.
- 3 Before you ride the bike, first check that the seat post is securely clamped.

Adjusting The Seat Post Quick Release Mechanism

The action of the quick release cam squeezes the seat collar around the seat post to hold the seat post securely in place. The amount of clamping force is controlled by the tension-adjusting nut. Turning the tension-adjusting nut clockwise while keeping the cam lever from rotating increases clamping force; turning it anticlockwise while keeping the cam lever from rotating reduces clamping force. Less than half a turn of the tension-adjusting nut can make the difference between safe and unsafe clamping force.



WARNING: The full force of the cam action is needed to clamp the seat post securely. Holding the nut with one hand and turning the lever like a wing nut with the other hand until everything is as tight as you can get it will not clamp the seat post safely.

? Need assistance?

Ask your local Halfords Bikehut store

24



WARNING: If you can fully close the quick release without wrapping your fingers around the seat post or a frame tube for leverage, and the lever does not leave a

clear imprint in the palm of your hand, the tension is insufficient. Open the lever; turn the tension-adjusting nut clockwise a quarter turn; then try again.

C. Brakes



WARNING:

- 1 Riding with improperly adjusted brakes or worn brake blocks is dangerous and can result in serious injury or death.
- 2 Applying brakes too hard or too suddenly can lock up a wheel, which could cause you to lose control and fall. Sudden or excessive application of the front brake may pitch the rider over the handlebars, which may result in serious injury or death.
- 3 Some bicycle brakes, such as disc brakes (fig. 14) and V brakes (fig. 15), are extremely powerful. Take extra care in becoming familiar with these brakes and exercise particular care when using them.
- 4 Disc brakes can get extremely hot with extended use. Be careful not to touch a disc brake until it has had plenty of time to cool.
- 5 See the brake manufacturer's instructions for operation and care of your brakes. If you do not have the manufacturer's instructions, see your Halfords Bikehut store or contact the brake manufacturer.

understand the way the brake quick release works on your bike (see figs. 14 through to 18) and check each time to make sure both brakes work correctly before you get on the bike.

2 How Brakes Work

The braking action of a bicycle is a function of the friction between the brake surfaces – usually the brake blocks and the wheel rim.

To make sure that you have maximum friction available, keep your wheel rims and brake blocks clean and free of dirt, lubricants, waxes or polishes. Do not allow the build up of road and trail dirt on the rims; this acts as an abrasive and can cause the rims to wear to the point where the sidewalls could fail.

If a rim fails the wheel will collapse, which could result in serious injury to the rider. Regularly check the rims and immediately replace any wheel where the rim shows significant wear. Some rims include wear indicator grooves or dimples in the braking surface. These rims are identified by the application of rim wear warning stickers, shown below:

1 Brake Control And Features

It's very important to your safety that you learn and remember which brake lever controls which brake on your bike. The right hand lever controls the front brake and the left controls the rear.

Make sure that your hands can reach and squeeze the brake levers comfortably. If your hands are too small to operate the levers comfortably, consult your Halfords Bikehut store before riding the bike. The lever reach may be adjustable; or you may need a different brake lever design.

Most brakes have some form of quick-release mechanism to allow the brake blocks to clear the tyre when a wheel is removed or reinstalled. When the brake quick release is in the open position, the brakes are inoperative. Ask your Halfords Bikehut store to make sure that you



If the rim has worn to the bottom of the wear Indicator groove or dimple, at any point on the braking surfaces, do not ride the cycle until the rim has been replaced.

Fig. 14

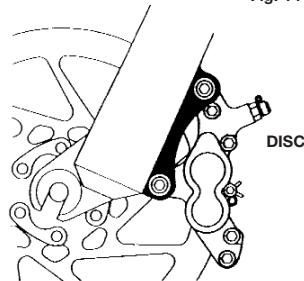

Brakes are designed to control your speed, not just to stop the bike. Maximum braking force for each wheel occurs at the point just before the wheel "locks up" (stops rotating) and starts to skid. Once the tyre skids, you actually lose most of your stopping force and all directional control. You need to practice slowing and stopping smoothly without locking up a wheel. The technique is called progressive brake modulation. Instead of jerking the brake lever to the position where you think you'll generate appropriate braking force, squeeze the lever, progressively increasing the braking force. If you feel the wheel begin to lock up, release pressure just a little to keep the wheel rotating just short of lockup. It's important to develop a feel for the amount of brake lever pressure required for each wheel at different speeds and on different surfaces. To better understand this, experiment a little by walking your bike and applying different amounts of pressure to each brake lever, until the wheel locks.

When you apply one or both brakes, the bike begins to slow, but your body wants to continue at the speed at which it was going. This causes a transfer of weight to the front wheel (or, under heavy braking, around the front wheel hub, which could send you flying over the handlebars).

A wheel with more weight on it will accept greater brake pressure before lockup; a wheel with less weight will lock up with less brake pressure. So, as you apply brakes and your weight is transferred forward, you need to shift your body toward the rear of the bike, to transfer weight back on to the rear wheel; and at the same time, you need to both decrease rear braking and increase front braking force. This is even more important on descents, because descents shift weight forward.

Two keys to effective speed control and safe stopping are controlling wheel lockup and weight transfer. This weight transfer is even more pronounced if your bike has a front suspension fork. Front suspension "dips" under braking, increasing the weight transfer (see also Section 4.F).

Practice braking and weight transfer techniques where there is no traffic or other hazards and distractions.

Everything changes when you ride on loose surfaces or in wet weather. Tyre adhesion is reduced, so the wheels have less cornering and braking traction and can lock up with less brake force. Moisture or dirt on the brake blocks reduces their ability to grip.

The best way to maintain control on loose or wet surfaces is to go more slowly to begin with.

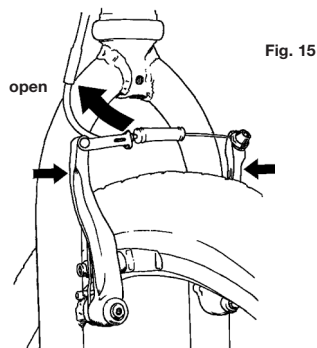

Fig. 15

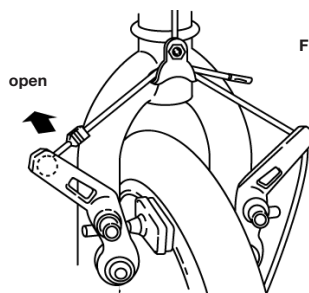

Fig. 16

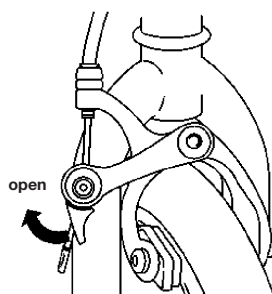

Fig. 17

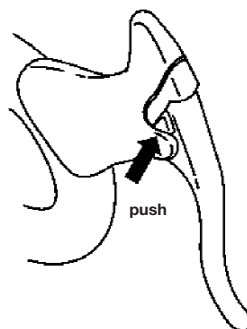

Fig. 18

? Need assistance?

Ask your local Halfords Bikehut store

26

3 Brake Power Modulators

Some V brakes have a brake modulator fitted in the control cable. This reduces the severity of the application of the brakes, helping the rider to achieve a smooth safe stop. Modulators are non adjustable and do not require any specific maintenance.

4 Brake Blocks And Pads

Brake blocks must be replaced when they have worn to the base of the grooves in the friction surface. Disc brake pads must be replaced when the friction material has worn to a thickness of 0.5 mm (minimum of 1mm for Shimano pads).

For best performance and braking power new disc brake pads and brake blocks need to be 'bedded in'. 'Bed in' the brakes by riding at a moderate speed and firmly braking to a walking pace, repeat this several times. Then ride at a faster speed and brake very firmly to a walking pace, several times.

5 BMX Rotor

Some BMX bikes are fitted with a rotor beneath the handlebars. This device connects the cables between the brake lever and the rear brake, whilst allowing the rider to rotate the handlebars through 360 degrees. The threaded cable adjusters fitted here must be adjusted carefully to ensure the correct operation of the rear brake. Always check that the rear brake is functioning correctly after making any cable adjustments.

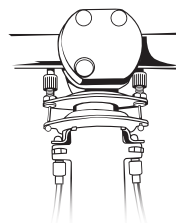

D. Shifting Gears

Your multi-speed bicycle will have a derailleur drive train or an internal gear hub drive train.

1 How a Derailleur Drive Train Works

If your bicycle has a derailleur drive train, the gear-changing mechanism will have:

- a rear cassette or freewheel sprocket cluster
- a rear derailleur
- usually a front derailleur
- one or two shifters
- one, two or three front sprockets called chainrings
- a drive chain

a. Shifting Gears

Your multi-speed bicycle will either have a derailleur drive train or an internal gear hub drive train. There are several different types and styles of shifting controls: levers, twist grips, triggers, combination shift/brake controls and push buttons. Ask your Halfords Bikehut store to explain the type of shifting controls that are on your bike, and to show you how they work. The vocabulary of shifting can be pretty confusing. A downshift is a shift to a "lower" or "slower" gear, one which is easier to pedal. An upshift is a shift to a "higher" or "faster", harder to pedal gear. What's confusing is that what's happening at the front derailleur is the opposite of what's happening at the rear derailleur (for

details, read the instructions on Shifting the Rear Derailleur and Shifting the Front Derailleur below). For example, you can select a gear which will make pedaling easier on a hill (make a downshift) in one of two ways: shift the chain down the gear "steps" to a smaller gear at the front, or up the gear "steps" to a larger gear at the rear. So, at the rear gear cluster, what is called a downshift looks like an upshift. The way to keep things straight is to remember that shifting the chain in towards the centreline of the bike is for accelerating and climbing and is called a downshift. Moving the chain out or away from the centreline of the bike is for speed and is called an upshift.

Whether upshifting or downshifting, the bicycle derailleur system design requires that the drive chain be moving forward and be under at least some tension. A derailleur will shift only if you are pedaling forward.



CAUTION: Never move the shifter whilst stationary, whilst pedalling backwards, or pedal backwards immediately after having moved the shifter. This could jam the chain and cause serious damage to the bicycle.

b. Shifting the Rear Derailleur

The rear derailleur is controlled by the right shifter. The function of the rear derailleur is to move the drive chain from one gear sprocket to another. The smaller sprockets on the gear cluster produce higher gear ratios. Pedaling in the higher gears requires greater pedaling effort, but takes you a greater distance with each revolution of the pedal cranks. The larger sprockets produce lower gear ratios. Using them requires less pedaling effort, but takes you a shorter distance with each pedal crank revolution. Moving the chain from a smaller sprocket of the gear cluster to a larger sprocket results in a downshift. Moving the chain from a larger sprocket to a smaller sprocket results in an upshift. In order for the derailleur to move the chain from one sprocket to another, the rider must be pedaling forward.

c. Shifting the Front Derailleur:

The front derailleur, which is controlled by the left shifter, shifts the chain between the larger and smaller chainrings. Shifting the chain onto a smaller chainring makes pedaling easier (a downshift). Shifting to a larger chainring makes pedaling harder (an upshift).

d. Which Gear Should I Be In?

The combination of largest rear and smallest front gears (fig. 19) is for the steepest hills. The smallest rear and largest front combination is for the greatest speed. It is not necessary to shift gears in sequence. Instead, find the "starting gear" which is right for your level of ability – a gear which is hard enough for quick acceleration but easy enough to let you start from a stop without wobbling – and experiment with upshifting and downshifting to get a feel for the different gear combinations. At first, practice shifting where there are no obstacles, hazards or other traffic, until you've built up your confidence. Learn to anticipate the need to shift, and shift to a lower gear before the hill gets too steep or you have to stop at a road junction. If you have difficulties with shifting, the problem could be mechanical adjustment, see your Halfords Bikehut store for help.



CAUTION: Never ride with the gears set to the combination of either the largest chainring and the largest rear sprocket or the smallest chainring and the smallest rear sprocket. These gear combinations cause the chain to run at extreme angles, shift to another chainring and another rear sprocket to achieve a similar gear ratio.

e. Adjustment



WARNING: Set up and adjustment of derailleur gears requires specialist knowledge. Do not begin any adjustments or service on your bicycle until you have learned from your Halfords Bikehut store how to properly complete them. Improper adjustment or service may result in damage to the bicycle or in an accident, which can cause serious injury or death.

See the gear manufacturer's instructions for operation and care of your gears. If you do not have the manufacturer's instructions, see your Halfords Bikehut store or contact the gear manufacturer.

Fig. 19

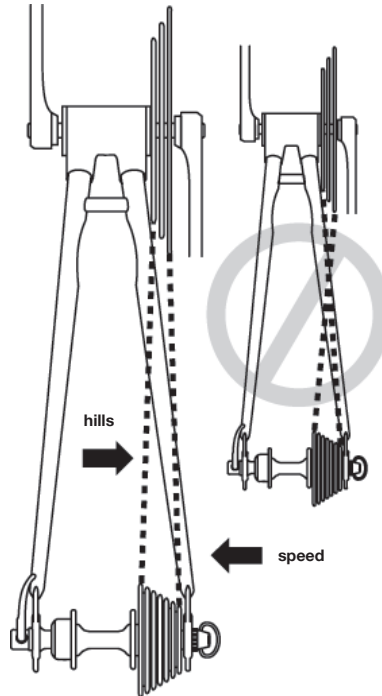

WARNING: Never shift a derailleur onto the largest or the smallest sprocket if the derailleur is not shifting smoothly. The derailleur may be out of adjustment and the chain could jam, causing you to lose control and fall.

? Need assistance?

Ask your local Halfords Bikehut store

28

2 How An Internal Gear Hub Drive Train Works

If your bicycle has an internal gear hub drive train, the gear changing mechanism will consist of:

- a 3, 5, 7, 8, 9 or possibly 12 speed internal gear hub
- one, or sometimes two shifters
- one or two control cables
- one front sprocket called a chainring
- a drive chain

a. Shifting Internal Gear Hub Gears

Shifting with an internal gear hub drive train is simply a matter of moving the shifter to the indicated position for the desired gear. After you have moved the shifter to the gear position of your choice, ease the pressure on the pedals for an instant to allow the hub to complete the shift.

b. Which Gear Should I Be In?

The numerically lowest gear (1) is for the steepest hills. The numerically largest gear (3, 5, 7, 8, 9 or 12, depending on the number of speeds of your hub) is for the greatest speed. Shifting from an easier, "slower" gear (like 1) to a harder, "faster" gear (like 2 or 3) is called an upshift. Shifting from a harder, "faster" gear to an easier, "slower" gear is called a downshift. It is not necessary to shift gears in sequence. Instead, find the "starting gear" for the conditions – a gear which is hard enough for quick acceleration but easy enough to let you start from a stop without wobbling – and experiment with upshifting and downshifting to get a feel for the different gears. At first, practice shifting where there are no obstacles, hazards or other traffic, until you've built up your confidence. Learn to anticipate the need to shift, and shift to a lower gear before the hill gets too steep. If you have difficulties with shifting, the problem could be mechanical adjustment, see your Halfords Bikehut store for help.

E. Pedals

- 1 Toe Overlap is when your toe can touch the front wheel when you turn the handlebars to steer while a pedal is in the forward most position. This is possible if you fit larger / wider tyres or longer replacement cranks, and is avoided by keeping the inside pedal up and the outside pedal down when making sharp turns. On any bicycle, this turning technique will prevent the inside pedal from striking the ground.



WARNING: Toe Overlap could cause you to lose control and fall. Ask your Halfords Bikehut store to help you determine if the combination of frame size, crank arm length, pedal design and shoes you will use results in pedal overlap.

Whether you have overlap or not, you must keep the inside pedal up and the outside pedal down for maximum ground clearance when making sharp turns.

- 2 Some bicycles come equipped with pedals that have sharp and potentially dangerous surfaces. These surfaces are designed to add safety by increasing grip between the rider's

shoe and the pedal. If your bicycle has this type of high-performance pedal, you must take extra care to avoid serious injury from the pedals' sharp surfaces. Based on your riding style or skill level, you may prefer a less aggressive pedal design, or chose to ride with shin pads. Your Halfords Bikehut store can show you a number of options and make suitable recommendations.

- 3 Toeclips and straps are a means to keep feet correctly positioned and engaged with the pedals. The toeclip positions the ball of the foot over the pedal spindle, which gives maximum pedaling power. The toe strap, when tightened, keeps the foot engaged throughout the rotation cycle of the pedal. While toeclips and straps give some benefit with any kind of shoe, they work most effectively with cycling shoes designed for use with toeclips. Your Halfords Bikehut store can explain how toeclips and straps work. Shoes with deep treaded soles or welts, which might make it more difficult for you to remove your foot, should not be used with toeclips and straps.



WARNING: Getting into and out of pedals with toeclips and straps requires skill which can only be acquired with practice. Until it becomes a reflex action, this technique requires concentration, which can distract your attention and cause you to lose control and fall. Practice the use of toeclips and straps where there are no obstacles, hazards or traffic. Keep the straps loose, and don't tighten them until your technique and confidence in getting in and out of the pedals warrants it. Never ride in traffic with your toe straps tight.

- 4 Clipless pedals (sometimes called "SPD type pedals") are another means to keep feet securely in the correct position for maximum pedaling efficiency. They have a plate, called a "cleat," on the sole of the shoe, which clicks into a mating spring-loaded fixture on the pedal. They only engage or disengage with a very specific motion, which must be practiced until it becomes instinctive. Clipless pedals require shoes and cleats, which are compatible with the make and model of pedal being used.

Many clipless pedals are designed to allow the rider to adjust the amount of force needed to

engage or disengage the foot. Follow the pedal manufacturer's instructions, or ask your Halfords Bikehut store to show you how to make this adjustment. Use the easiest setting until engaging and disengaging becomes a reflex action, but always make sure that there is sufficient tension to prevent unintended release of your foot from the pedal.



WARNING: Clipless pedals are intended for use with shoes specifically made to fit them and are designed to firmly keep the foot engaged with the pedal. Using shoes which do not engage the pedals correctly is dangerous.

Practice is required to learn to engage and disengage the foot safely. Until engaging and disengaging the foot becomes a reflex action, the technique requires concentration which can distract your attention and cause you to lose control and fall. Practice engaging and disengaging clipless pedals in a place where there are no obstacles, hazards or traffic; and be sure to follow the pedal manufacturer's setup and service instructions. If you do not have the manufacturer's instructions, see your Halfords Bikehut store or contact the manufacturer.

Many mountain bike and BMX pedals are designed with high grip tread surfaces. These can be rougher than ordinary bicycle pedals and they may have sharper edges. Riders should wear adequate safety protection.

F. Bicycle Suspension

Many bicycles are equipped with suspension systems. There are many different types of suspension systems – too many to deal with individually in this Manual. If your bicycle has a suspension system of any kind, be sure to read and follow the suspension manufacturer's setup and service instructions. If you do not have the manufacturer's instructions, see your Halfords Bikehut store or contact the manufacturer.

Winding a rear suspension spring tension nut anti-clockwise will increase the travel of the rear suspension, for a given load. However, never reduce this pre-tension to such an extent that the spring becomes loose when you lift the bike off the ground.

Regularly inspect all suspension joints and bushes for wear. If there is excessive play do not ride the bicycle until that joint or bush has been replaced.



WARNING: Failure to maintain, check and properly adjust the suspension system may result in suspension malfunction, which may cause you to lose control and fall.

If your bike has suspension, the increased speed you may develop also increases your risk of injury. For example, when braking, the front of a suspended bike dips. You could lose control and fall if you do not have experience with this system. Learn to handle your suspension system safely. See also Section 4.C.

? Need assistance?

Ask your local Halfords Bikehut store

30



WARNING: Changing suspension adjustment can change the handling and braking characteristics of your bicycle. Never change suspension adjustment unless you are thoroughly familiar with the suspension system manufacturer's instructions and recommendations, and always check for changes in the handling and braking characteristics of the bicycle after a suspension adjustment by taking a careful test ride in a hazard-free area.

Suspension can increase control and comfort by allowing the wheels to better follow the terrain. This enhanced capability may allow you to ride faster; but you must not confuse the enhanced capabilities of the bicycle with your own capabilities as a rider. Increasing your skill will take time and practice. Proceed carefully until you have learned to handle the full capabilities of your bike.



CAUTION: Not all bicycles can be safely retrofitted with some types of suspension systems. Before retrofitting a bicycle with any suspension, check with the bicycle's manufacturer to make sure that what you want to do is compatible with the bicycle's design.

G. Tyres and Tubes

Fig. 20

1 Tyres

Bicycle tyres are available in many designs and specifications, ranging from general-purpose designs to tyres designed to perform best under very specific weather or terrain conditions. If, once you've gained experience with your new bike, you feel that a different tyre might better suit your riding needs, your Halfords Bikehut store can help you select the most appropriate design.

The size, pressure rating, and on some high performance tyres the specific recommended use, are marked on the sidewall of the tyre (see fig. 20). The part of this information, which is most important to you, is tyre pressure.



WARNING: Never inflate a tyre beyond the maximum pressure marked on the tyre's sidewall. Exceeding the recommended maximum pressure may blow the tyre off the rim, which could cause damage to the bike and injury to the rider and bystanders.

The best and safest way to inflate a bicycle tyre to the correct pressure is with a bicycle pump, which has a built-in pressure gauge.

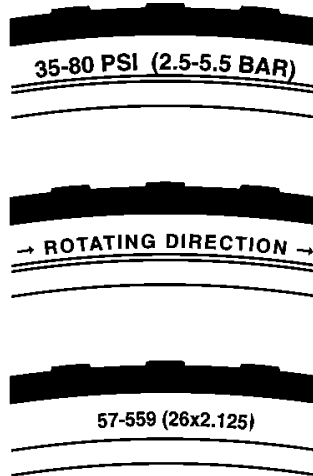

WARNING: There is a safety risk in using petrol station air hoses or other air compressors. They are not made for bicycle tyres. They move a large volume of air very rapidly, and will raise the pressure in your tyre very rapidly, which could cause the tube to explode.

Tyre pressure is given either as maximum pressure or as a pressure range. How a tyre performs under different terrain or weather conditions depends largely on tyre pressure. Inflating the tyre to near its maximum recommended pressure gives the lowest rolling resistance; but also produces the harshest ride. High pressures work best on smooth, dry pavement. Very low pressures, at the bottom of the recommended pressure range, give the best performance on smooth, slick terrain such as hard-packed clay, and on deep, loose surfaces such as deep, dry sand. Tyre pressure that is too low for your weight and the riding conditions can cause a puncture of the tube by allowing the tyre to deform sufficiently to pinch the inner tube between the rim and the riding surface. Ask your Halfords Bikehut store to recommend the best tyre pressure for the kind of riding you will most often do. Inflate your tyres to that pressure, using a pressure gauge. Then, check inflation as described in Section 1.C so you'll know how correctly inflated tyres should look and feel when you don't have access to a gauge. Some tyres may need to be brought up to pressure every week or two.

Some special high-performance tyres have unidirectional treads: their tread pattern is designed to work better in one direction than in the other. The sidewall marking of a unidirectional tyre will have an arrow showing the correct rotation direction. If your bike has unidirectional tyres, make sure that they are mounted to rotate in the correct direction.

2 Tyre Valves

There are primarily two kinds of bicycle tube valves: The Schraeder Valve and the Presta Valve. The bicycle pump you use must have the fitting appropriate to the valve stems on your bicycle.

The Schraeder valve is like the valve on a car tyre. To inflate a Schraeder valve tube, remove the valve cap and clamp the pump fitting onto the end of the valve stem. To let air out of a Schraeder valve, depress the pin in the end of the valve stem with the end of a key or other appropriate object.

The Presta valve (fig. 21) has a narrower diameter and is only found on bicycle tyres. To inflate a Presta valve tube using a Presta headed bicycle pump, remove the valve cap; unscrew (anticlockwise) the valve stem lock nut; and push down on the valve stem to free it up. Then push the pump head on to the valve head, and inflate.

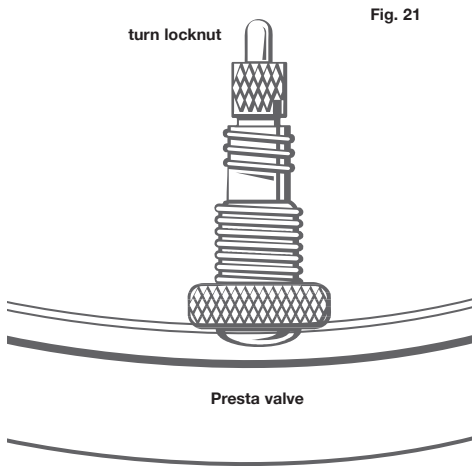

Fig. 21

To inflate a Presta valve with a Schraeder pump fitting, you'll need a Presta adapter (available at your Halfords Bikehut store) which screws on to the valve stem once you've freed up the valve. The adapter fits into the Schraeder pump fitting. Close the valve after inflation. To let air out of a Presta valve, open up the valve stem lock nut and depress the valve stem.



WARNING: Patching a tube is an emergency repair. If you do not apply the patch correctly or apply several patches, the tube can fail, resulting in possible tube failure, which could cause you to lose control and fall. Replace a patched tube as soon as possible.

H. BMX Stunt pegs

Your BMX bike may come equipped with stunt pegs, regularly check that the stunt pegs are securely tightened. If your BMX has extended wheel axles, with two sets of wheel nuts on each axle, it will be suitable for fitting aftermarket stunt pegs.

? Need assistance?

Ask your local Halfords Bikehut store

5. Servicing



WARNING: Technological advances have made bicycles and bicycle components more complex, and the pace of innovation is increasing. It is impossible for this manual to provide all the information required to properly repair and/or maintain your bicycle. In order to help minimize the chances of an accident and possible injury, it is critical that you have any repair or maintenance, which is not specifically described in this manual, performed by your Halfords Bikehut store. Equally important is that your individual maintenance requirements will be determined by everything from your riding style to geographic location. Consult your Halfords Bikehut store for help in determining your maintenance requirements.



WARNING: Many bicycle service and repair tasks require special knowledge and tools. Do not begin any adjustments or service on your bicycle until you have learned from your Halfords Bikehut store how to properly complete them. Improper adjustment or service may result in damage to the bicycle or in an accident, which can cause serious injury or death.

If you want to learn to do major service and repair work on your bike:

- 1 Check the many useful How to Guides / Videos and Expert Advice articles available on Halfords.com or Halfords.ie at Cycling / Help & Advice.
- 2 Ask your Halfords Bikehut store for copies of the manufacturer's installation and service instructions for the components on your bike, or contact the component manufacturer.
- 3 Ask your Halfords Bikehut store to recommend a book on bicycle repair.

We recommend that you ask your Halfords Bikehut store to check the quality of your work the first time you work on something and before you ride the bike, just to make sure that you did everything correctly. Since that will require the time of a mechanic, there may be a modest charge for this service.

A. Service Intervals

Some service and maintenance can and should be performed by the owner, and requires no special tools or knowledge beyond what is presented in this manual.

The following are examples of the type of service you should perform yourself. All other service, maintenance and repairs should be performed in a properly equipped facility by a qualified bicycle mechanic using the correct tools and procedures specified by the manufacturer.

- 1 Break-in Period: Your bike will last longer and work better if you break it in before riding it hard. Control cables and wheel spokes may stretch or "seat" when a new bike is first used and may require readjustment by your Halfords Bikehut store. Your Mechanical Safety Check (Section 1.C) will help you identify some things that need readjustment. But even if everything seems fine to you, it's best to take your bike back to the Halfords Bikehut store for a checkup.

Another way to judge when it's time for the first checkup is to bring the bike in after three to five hours of hard off-road use, or about 10 to 15 hours of on-road or more casual off-road use. But if you think something is wrong with the bike, take it to your Halfords Bikehut store before riding it again.

- 2 Before every ride: carry out the Mechanical Safety Check (Section 1.C)
- 3 After every long or hard ride: especially if the bike has been exposed to water or grit; or at least every 100 miles: Clean the bike and lightly oil the chain. Wipe off any excess oil. Apply an aerosol spray lubricant to the brake and gear control cables, to ensure that they move freely.

The need for lubrication is affected by the climate in which you ride. Talk to your Halfords Bikehut store about the best lubricants and the recommended lubrication frequency for your area.

4 After every long or hard ride or after every 10 to 20 hours of riding:

- Squeeze the front brake and rock the bike forward and back. Everything feel solid? If you feel a clunk with each forward or backward movement of the bike, you probably have a loose headset. Have your Halfords Bikehut store check it.
- Lift the front wheel off the ground and swing it from side to side. Feel smooth? If you feel any binding or roughness in the steering, you may have a tight headset. Have your Halfords Bikehut store check it.
- Grab one pedal and rock it toward and away from the centreline of the bike; then do the same with the other pedal. Anything feel loose? If so, have your Halfords Bikehut store check it.
- Take a look at the brake blocks. Starting to look worn or not hitting the wheel rim squarely? Time to have the Halfords Bikehut store adjust or replace them.
- Carefully check the control cables and cable housings. Any rust? Kinks? Fraying? If so, have your Halfords Bikehut store replace them.
- Squeeze each adjoining pair of spokes on either side of each wheel between your thumb and index finger. Do they all feel about the same? If any feel loose, have your Halfords Bikehut store check the wheel for tension and trueness.
- Check to make sure that all parts and accessories are still secure, and tighten any that are not.
- Check the frame, particularly in the area around all tube joints; the handlebars; the stem; and the seat post for any deep scratches, cracks or discoloration. These are signs of stress-caused fatigue and indicate that a part is at the end of its useful life and needs to be replaced. See Appendix A.



WARNING: Like any mechanical device, a bicycle and its components are subject to wear and stress. Different materials and mechanisms wear or fatigue from stress at different rates and have different life cycles. If a component's life cycle is exceeded, the component can suddenly and catastrophically fail, causing serious injury or death to the rider. Scratches, cracks, fraying and discoloration are signs of stress-caused fatigue and indicate that a part is at the end of its useful life and needs to be replaced. While the materials and workmanship of your bicycle or of individual components may be covered by a warranty for a specified period of time by the manufacturer, this is no guarantee that the product will last the term of the warranty. Product life is often related to the kind of riding you do and to the treatment to which you submit the bicycle. The bicycle's warranty is not meant to suggest that the bicycle cannot be broken or will last forever. It only means that the bicycle is covered subject to the terms of the warranty. Please be sure to read Appendix A, Life Expectancy Of Your Bike And Its Components, starting on page 35.

- 5 If either brake lever fails the Mechanical Safety Check (Section 1.C), don't ride the bike. Have your Halfords Bikehut store check the brakes.
- 6 If the chain won't shift smoothly and quietly from gear to gear, the derailleur is out of adjustment. See your Halfords Bikehut store.

B. If Your Bicycle Sustains An Impact

First check yourself for injuries, and take care of them as best you can. Seek medical help if necessary. Next check your bike for damage. After any crash take your bike to your Halfords Bikehut store for a thorough check.

Carbon frames and forks require very careful examination after any crash. See Appendix A, Life expectancy of your bike and its components



WARNING: A crash or other impact can put extraordinary stresses on bicycle components, causing them to fatigue prematurely. Components suffering from stress fatigue can fail suddenly and catastrophically, causing loss of control, serious injury or death. Even if a helmet that has sustained an impact is not broken, it must be replaced. The structure of the helmet is deformed in absorbing the impact and this damage will reduce the protection it offers.

? Need assistance?

Ask your local Halfords Bikehut store

34

Appendix A

Life Expectancy Of Your Bike And Its Components

1 Nothing Lasts Forever, Including Your Bike

When the useful life of your bike or its components is over, continued use is hazardous. Every bicycle and its component parts have a finite, limited useful life. The length of that life will vary with the construction and materials used in the frame and components; the maintenance and care the frame and components receive over their life; and the type and amount of use to which the frame and components are subjected.

Use in competitive events, trick riding, ramp riding, jumping, aggressive riding, riding on severe terrain, riding in severe climates, riding with heavy loads, commercial activities and other types of non-standard use can dramatically shorten the life of the frame and components. Any one or a combination of these conditions may result in an unpredictable failure.

All aspects of use being identical, lightweight bicycles and their components will usually have a shorter life than heavier bicycles and their components. In selecting a lightweight bicycle or components you are making a tradeoff, favoring the higher performance that comes with lighter weight over longevity. So, if you choose lightweight, high performance equipment, be sure to have it inspected frequently.

You should have your bicycle and its components checked periodically by your Halfords Bikehut store for indicators of stress and/or potential failure, including cracks, deformation, corrosion, paint peeling, dents, and any other indicators of potential problems, inappropriate use or abuse. These are important safety checks and very important to help prevent accidents, bodily injury to the rider and shortened product life.

2 Perspective

Today's high-performance bicycles require frequent and careful inspection and service. In this Appendix we try to explain some underlying material science basics and how they relate to your bicycle. We discuss some of the trade-offs made in designing your bicycle and what you can expect from your bicycle; and we provide important, basic guidelines on how to maintain and inspect it. We cannot teach you everything you need to know to properly inspect and service your bicycle; and that is why we repeatedly urge you to take your bicycle to your Halfords Bikehut store for professional care and attention.



WARNING: Frequent inspection of your bike is important to your safety.

Follow the Mechanical Safety Check in Section 1.C of this Manual before every ride.

Periodic, more detailed inspection of your bicycle is important. How often this more detailed inspection is needed depends upon you. You, the rider/owner, have control and knowledge of how often you use your bike, how hard you use it and where you use it. Because your Halfords Bikehut store cannot track your use, you must take responsibility for periodically bringing your bike to your Halfords Bikehut store for inspection and service. Your Halfords Bikehut store will help you decide what frequency of inspection and service is appropriate for how and where you use your bike.

For your safety, understanding and communication with your Halfords Bikehut store, we urge you to read this Appendix in its entirety.

The materials used to make your bike determine how and how frequently to inspect.

Ignoring this WARNING can lead to frame, fork or other component failure, which can result in serious injury or death.

A. Understanding Metals

Steel is the traditional material for building bicycle frames. It has good characteristics, but in high performance bicycles, steel has been largely replaced by aluminium and occasionally by titanium. The main factor driving this change is interest by cycling enthusiasts in lighter bicycles.

Properties of Metals

Please understand that there is no simple statement that can be made that characterizes the use of different metals for bicycles. What is true is how the metal chosen is applied is much more important than the material alone. One must look at the way the bike is designed, tested, manufactured, supported along with the characteristics of the metal rather than seeking a simplistic answer.

Metals vary widely in their resistance to corrosion. Steel must be protected or rust will attack it. Aluminium and titanium quickly develop an oxide film that protects the metal from further corrosion. Both are therefore quite resistant to corrosion. Aluminium is not perfectly corrosion resistant, and particular care must be used where it contacts other metals as galvanic corrosion can occur.

Metals are comparatively ductile. Ductile means bending, buckling and stretching before breaking. Generally speaking, of the common bicycle frame building materials steel is the most ductile, titanium less ductile, followed by aluminium.

Metals vary in density. Density is weight per unit of material. Steel weighs 7.8 grams/cm³ (grams per cubic centimeter), titanium 4.5 grams/cm³, aluminium 2.75 grams/cm³. Contrast these numbers with carbon fibre composite at 1.45 grams/cm³.

Metals are subject to fatigue. With enough cycles of use, at high enough loads, metals will eventually develop cracks that lead to failure. It is very important that you read the basics of metal fatigue below.

Let's say you hit a kerb, ditch, rock, car, another cyclist or other object. At any speed above a fast walk, your body will continue to move forward, momentum carrying you over the front of the bike. You cannot and will not stay on the bike, and what happens to the frame, fork and other components is irrelevant to what happens to your body. What should you expect from your metal frame? It depends on many complex factors, which is why we tell you that crashworthiness cannot be a design criteria. With that important note, we can tell you that if the impact is hard enough the fork or frame may be bent or buckled.

On a steel bike, the steel fork may be severely bent and the frame undamaged. Aluminium is less ductile than steel, but you can expect the fork and frame to be bent or buckled. Hit harder and the top tube may be broken in tension and the down tube buckled. Hit harder and the top tube may be broken, the down tube buckled and broken, leaving the head tube and fork separated from the main triangle. When a metal bike crashes, you will usually see some evidence of this ductility in bent, buckled or folded metal.

It is now common for the main frame to be made of metal and the fork of carbon fibre (see Section B, Understanding composites below). The relative ductility of metals and the lack of ductility of carbon fibre, means that in a crash scenario, you can expect some bending or buckling in the metal but none in the carbon. Below a given load the carbon fork may be intact even though the frame is damaged. Above that load the carbon fork will be completely broken.

? *Need assistance?*

Ask your local Halfords Bikehut store

36

The Basics of Metal Fatigue

Common sense tells us that nothing that is used lasts forever. The more you use something, and the harder you use it, and the worse the conditions you use it in, the shorter its life.

Fatigue is the term used to describe accumulated damage to a part caused by repeated loading. To cause fatigue damage, the load the part receives must be great enough. A crude, often-used example is bending a paper clip back and forth (repeated loading) until it breaks. This simple definition will help you understand that fatigue has nothing to do with time or age. A bicycle in a garage does not fatigue. Fatigue happens only through use.

So what kind of “damage” are we talking about? On a microscopic level, a crack forms in a highly stressed area. As the load is repeatedly applied, the crack grows. At some point the crack becomes visible to the naked eye. Eventually it becomes so large that the part is too weak to carry the load that it could carry without the crack. At that point there can be a complete and immediate failure of the part.

One can design a part that is so strong that fatigue life is nearly infinite. This requires a lot of material and a lot of weight. Any structure that must be light and strong will have a finite fatigue life. Aircraft, racing cars, motorcycles all have parts with finite fatigue lives. If you wanted a bicycle with an infinite fatigue life, it would weigh far more than any bicycle sold today. So we all make a tradeoff: the wonderful, lightweight performance we want requires that we inspect the structure.

A Few Things to Think About

<ul style="list-style-type: none"> • ONCE A CRACKS STARTS IT CAN GROW AND GROW FAST. Think about the crack as forming a pathway to failure. This means that any crack is potentially dangerous and will only become more dangerous. 	<p>SIMPLE RULE 1: If you find a crack, replace the part.</p>
<ul style="list-style-type: none"> • CORROSION SPEEDS DAMAGE. Cracks grow more quickly when they are in a corrosive environment. Think about the corrosive solution further weakening and extending the crack. 	<p>SIMPLE RULE 2: Clean your bike, lubricate your bike, protect your bike from salt, remove any salt as soon as you can.</p>
<ul style="list-style-type: none"> • STAINS AND DISCOLORATION CAN OCCUR NEAR A CRACK. Such staining may be a warning sign that a crack exists. 	<p>SIMPLE RULE 3: Inspect and investigate any staining to see if it is associated with a crack.</p>
<ul style="list-style-type: none"> • SIGNIFICANT SCRATCHES, GOUGES, DENTS OR SCORING CREATE STARTING POINTS FOR CRACKS. Think about the cut surface as a focal point for stress (in fact engineers call such areas “stress raisers,” areas where the stress is increased). Perhaps you have seen glass cut? Recall how the glass was scored and then broke on the scored line. 	<p>SIMPLE RULE 4: Do not scratch, gouge or score any surface. If you do, pay frequent attention to this area or replace the part.</p>
<ul style="list-style-type: none"> • SOME CRACKS (particularly larger ones) MAY MAKE CREAKING NOISES AS YOU RIDE. Think about such a noise as a serious warning signal. Note that a well-maintained bicycle will be very quiet and free of creaks and squeaks. 	<p>SIMPLE RULE 5: Investigate and find the source of any noise. It may not a be a crack, but whatever is causing the noise should be fixed promptly.</p>

In most cases a fatigue crack is not a defect. It is a sign that the part has worn out; a sign the part has reached the end of its useful life.

When your car tyres wear down to the point that the tread bars are contacting the road, those tyres are not defective. Those tyres are worn out and the tread bar says “time for replacement.”

When a metal part shows a fatigue crack, it is worn out. The crack says “time for replacement.”

Fatigue is not a Perfectly Predictable Science

Fatigue is not a perfectly predictable science, but here are some general factors to help you and your Halfords Bikehut store determine how often your bicycle should be inspected. The more you fit the “shorten product life” profile, the more frequent your need to inspect. The more you fit the “lengthen product life” profile, the less frequently you will need to inspect.

Factors that shorten product life:	Factors that lengthen product life:
• Hard, harsh riding style	• Smooth, fluid riding style
• “Hits,” crashes, jumps, other shocks to bike	• No “hits,” crashes, jumps, other shocks to bike
• High mileage	• Low mileage
• Higher body weight	• Lower body weight
• Stronger, more fit, more aggressive rider	• Less aggressive rider
• Corrosive environment (wet, salt air, winter road salt, accumulated sweat)	• Non-corrosive environment (dry, salt-free air)
• Presence of abrasive mud, dirt, sand, soil in the riding environment	• Clean riding environment



WARNING: Do not ride a bicycle or component with any crack, bulge or dent, even a small one. Riding a cracked frame, fork or component could lead to complete failure, with risk of serious injury or death.

B. Understanding Composites

All riders must understand a fundamental reality of composites. Composite materials constructed of carbon fibres are strong and light, but when crashed or overloaded, carbon fibres do not bend, they break.

What Are Composites?

The term “composites” refers to the fact that a part or parts are made up of different components or materials. You’ve heard the term “carbon fibre bike.” This really means “composite bike.”

Carbon fibre composites are typically a strong, light fibre in a matrix of resin, moulded to form a shape. Carbon composites are light relative to metals. Steel weighs 7.8 grams/cm³ (grams per cubic centimeter), titanium 4.5 grams/cm³, aluminium 2.75 grams/cm³. Contrast these numbers with carbon fibre composite at 1.45 grams/cm³.

The composites with the best strength-to-weight ratios are made of carbon fibre in a matrix of epoxy resin. The epoxy matrix bonds the carbon fibres together, transfers load to other fibres, and provides a smooth outer surface. The carbon fibres are the “skeleton” that carries the load.

Why Are Composites Used?

Unlike metals, which have uniform properties in all directions (engineers call this isotropic), carbon fibres can be placed in specific orientations to optimize the structure for particular loads. The choice of where to place the carbon fibres gives engineers a powerful tool to create strong, light bicycles. Engineers may also orient fibres to suit other goals such as comfort and vibration damping.



Need assistance?

Ask your local Halfords Bikehut store

38

Carbon fibre composites are very corrosion resistant, much more so than most metals. Think about carbon fibre or fibreglass boats.

Carbon fibre materials have a very high strength-to-weight ratio.

What are the Limits of Composites?

Well designed "composite" or carbon fibre bicycles and components have long fatigue lives, usually better than their metal equivalents.

While fatigue life is an advantage of carbon fibre, you must still regularly inspect your carbon fibre frame, fork, or components. Carbon fibre composites are not ductile. Once a carbon structure is overloaded, it will not bend; it will break. At and near the break, there will be rough, sharp edges and maybe delamination of carbon fibre or carbon fibre fabric layers. There will be no bending, buckling, or stretching.

If you Hit Something or have a Crash, What can you Expect from your Carbon Fibre Bike?

Let's say you hit a kerb, ditch, rock, car, other cyclist or other object. At any speed above a fast walk, your body will continue to move forward, the momentum carrying you over the front of the bike. You cannot and will not stay on the bike and what happens to the frame fork and other components is irrelevant to what happens to your body.

What should you expect from your carbon frame? It depends on many complex factors, which is why we tell you that crash worthiness cannot be a design criteria. With that important note, we can tell you that if the impact is hard enough, the fork or frame may be completely broken. Note the significant difference in behavior between carbon and metal (see Section 2. A, Understanding metals in this Appendix). Even if the carbon frame was twice as strong as a metal frame, once the carbon is overloaded it will not bend, it will break completely.

Inspection of Composite Frame, Fork, and Components

Cracks:

Inspect for cracks, broken, or splintered areas.

Any crack is serious. Do not ride any bicycle where the frame or any component has a crack of any size.

If your bike has a carbon fibre fork steerer tube, this part of the fork must be inspected with great care after any impact or crash. The fork has to be completely removed from the frame head tube, to allow close examination of the full length of the steerer tube for any signs of cracking or delamination.

Delamination:

Delamination is serious damage. Composites are made from layers of fabric. Delamination means that the layers of fabric are no longer bonded together. Do not ride any bicycle or component that has any delamination.

These are some delamination clues:

- A cloudy or white area. This kind of area looks different from the ordinary undamaged areas. Undamaged areas will look glassy, shiny, or "deep," as if one was looking into a clear liquid. Delaminated areas will look opaque and cloudy.
- Bulging or deformed shape. If delamination occurs, the surface shape may change. The surface may have a bump, a bulge, soft spot, or not be smooth and fair.
- A difference in sound when tapping the surface. If you gently tap the surface of an undamaged composite you will hear a consistent sound, usually a hard, sharp sound. If you then tap a delaminated area, you will hear a different sound, usually duller, less sharp.

Unusual Noises:

Either a crack or delamination can cause creaking noises while riding. Think about such a noise as a serious warning signal. A well maintained bicycle will be very quiet and free of creaks and squeaks. Investigate and find the source of any noise. It may not be a crack or delamination, but whatever is causing the noise must be fixed before riding.



WARNING: Do not ride a bicycle or component with any delamination or crack. Riding a delaminated or cracked frame, fork or other component could lead to complete failure, with risk of serious injury or death.

C. Understanding Components

It is often necessary to remove and disassemble components in order to properly and carefully inspect them. This is a job for a professional bicycle mechanic with the special tools, skills and experience to inspect and service today's high-tech high-performance bicycles and their components.

Aftermarket “Super Light” Components

Think carefully about your rider profile as outlined above. The more you fit the “shorten product life” profile, the more you must question the use of super light components. The more you fit the “lengthen product life” profile, the more likely it is that lighter components may be suitable for you. Discuss your needs and your profile very honestly with your Halfords Bikehut store. Take these choices seriously and understand that you are responsible for the changes you make.

Original Equipment Components

Bicycle and component manufacturers test the fatigue life of the components that are original equipment on your bike. This means that they have met test criteria and have a reasonable fatigue life.

It does not mean that the original components will last forever. **They won't.**

? ***Need assistance?***

Ask your local Halfords Bikehut store

40

6. Children's Bikes

Fitting Stabilisers

Loosen and remove both rear wheel axle nuts. Fit the rectangular washers over both ends of the axle, with their projecting tabs facing inwards. Slide the washers along the axle until their projecting tabs locate in the frame axle slot. Fit the stabilisers on to both sides of the rear axle and secure with the axle nuts. The stabilisers should be set at a height of approximately 12mm (1/2) above level ground, when the cycle is upright.

Riding with Stabilisers

Cycles fitted with stabilisers should only be used on smooth level surfaces. Do not use them on rough ground or over kerbs, as there is a risk that they may cause the rider to fall. Also do not use in overhanging bushes or weeds, where they could become entangled and cause the rider to fall.

When your child can safely balance their bicycle, the stabilisers may be removed.

Braking Control

It is particularly important that you teach your child how to safely use the brakes fitted to their bicycle. For best performance, both brakes should be used simultaneously. The front brake should never just be used on its own, as this could cause the rider to fall over the handlebars.

It is important to have your bike inspected at regular intervals - it will ensure that you get the best from your bike.

Keep this handbook in a safe place, as it is a useful reminder as well as full of useful tips to keep your bike in good working order.

Pre-delivery inspection

Make.....
 Size.....
 Mode.....
 Colour.....
 Frame No.....
 Contact.....
 Date.....

Store Stamp

Signed.....

6 weeks inspection

Frame.....
 Wheels & Tyres.....
 Brakes.....
 Gears.....
 Drive Train.....
 Forks.....
 Date.....

Free of charge

 Store Stamp

Signed.....

6 months inspection

Frame.....
 Wheels & Tyres.....
 Brakes.....
 Gears.....
 Drive Train.....
 Forks.....
 Date.....

Store Stamp

Signed.....

12 months inspection

Frame.....
 Wheels & Tyres.....
 Brakes.....
 Gears.....
 Drive Train.....
 Forks.....
 Date.....

Store Stamp

Signed.....